



PLANAR LCD MONITOR PV150 MANUAL

www.planar.com



PREFACE

About this manual

This manual is designed to assist you in setting up and using your New Planar LCD Monitor. Information in this document has been carefully checked for accuracy; however, no guarantee is given to the correctness of the contents. The information in this document is subject to change without notice. This document contains proprietary information protected by copyright. All rights are reserved. No part of this manual may be reproduced by any mechanical, electronic or other means, in any form, without prior written permission of the manufacturer.

FCC Compliance Statement

This device complies with part 15 of the FCC Rules. Operation is subject to the following two conditions:

1. this device may not cause harmful interference, and
2. this device must accept any interference received, including interference that may cause undesired operation.

FCC WARNING

This equipment has been tested and found to comply with the limits for a Class B digital device, pursuant to Part 15 of the FCC Rules. These limits are designed to provide reasonable protection against harmful interference in a residential installation.

This equipment generates, uses and can radiate radio frequency energy and, if not installed and used in accordance with the instructions, may cause harmful interference to radio communications.

However, there is no guarantee that interference will not occur in a particular installation. If this equipment does cause harmful interference to radio or television reception, which can be determined by turning the equipment off and on, the user is encouraged to try to correct the interference by one or more of the following measures:

- Reorient or relocate the receiving antenna.
- Increase the separation between the equipment and the receiver.
- Connect the equipment into an outlet different from that to which the receiver is connected.
- Consult the dealer or an experienced radio/TV technician for help.

Caution:

To comply with the limits for an FCC Class B computing device, always use the shielded signal cord supplied with this unit.

The Federal Communications Commission warns that changes or modifications of the unit not expressly approved by the party responsible for compliance could void the user's authority to operate the equipment.

**CE mark for Class B ITE (Following European standard EN55022/1998;
EN61000-3-2/1995; EN61000-3-3/1995, EN55024/1998)**

Radio Frequency Interference Statement

Warning:

This is a Class B product. In a domestic environment, this product may cause radio interference in which case the user may be required to take adequate measures.

Canadian Doc Notice

For Class B Computing Devices



This digital apparatus does not exceed the Class B limits for radio noise emissions from digital apparatus as set out in the Radio Interference Regulation of the Canadian Department of Communications.

“Le présent appareil numérique n’émet pas de bruits radioélectriques dépassant les limites applicables aux appareils numériques de la class B prescrites dans le Règlement sur le brouillage radioélectrique édicté par le ministère des Communications du Canada”

Important Safety Instructions

Please read the following instructions carefully. This manual should be retained for future use.

1. To clean your New Planar LCD Monitor screen, first, make sure the Monitor is in the power off mode. Unplug the Monitor from its power source before cleaning it. Do not spray liquid cleaners directly onto the unit. Stand away from your New Planar LCD Monitor and spray cleaning solution onto a rag. Without applying excessive pressure, clean the screen with the slightly dampened rag.
2. Do not place your New Planar LCD Monitor near a window. Exposing the Monitor to rain, water, moisture or sunlight can severely damage it.
3. Do not place anything on top of the Monitor-to-PC signal cord. Make sure the cord is placed in an area where it will not be stepped on.
4. Do not apply pressure to the LCD screen. Excessive pressure may cause permanent damage to the display.
5. Do not remove the cover or attempt to service this unit by yourself. You may void the warranty. Only an authorized technician should perform servicing.
6. Safe storage of your New Planar LCD Monitor is in a range of minus 20 to plus 65 degrees Celsius (68°F-149°F). Storing your New Planar LCD Monitor outside this range could result in permanent damage.
7. If any of the following occurs, immediately unplug your Monitor and call an authorized technician.
 - The power or Monitor-to-PC signal cord is frayed or damaged.
 - Liquid has been spilled onto the Monitor, or it has been exposed to rain.
 - The Monitor has been dropped or the case has been damaged.
8. The appliance should be disconnected from the mains by pulling the mains power cord/mains plug.
9. The socket-outlet shall be installed near the equipment and shall be easily accessible.



TABLE OF CONTENTS

PREFACE..... I

TABLE OF CONTENTS..... III

CHAPTER 1 1

Your New Planar LCD Monitor!..... 1

Unpacking 1

Identifying Components 1

Your New Planar LCD Monitor — Front View..... 2

Your New Planar LCD Monitor — Rear View..... 2

Adjusting the Monitor's Position 3

Connecting AC Power..... 3

Connecting Video 4

Connecting the Stereo Speakers 4

Connecting USB Devices 5

Upstream..... 5

Downstream..... 5

Power Management System..... 5

CHAPTER 2 6

LCD Monitor Control Panel 6

Adjusting the Display..... 6

OSD Main Menu 6

APPENDIX A 10

Planar TFT LCD Monitor Specifications..... 10

APPENDIX B 11

Timing for Model WT1503Z (XGA Resolution)..... 11

APPENDIX C 12

Troubleshooting Procedures 12

Your New Planar LCD Monitor

Your New Planar LCD Monitor!

Your New Planar LCD Monitor has been designed to be versatile, ergonomic and user-friendly. Your New Planar LCD Monitor is capable of displaying most standards, from 640 x 480 VGA to 1024 x 768 XGA. The digital controls located on the front panel allow the user to easily adjust the Monitor's display parameters. Your New Planar LCD Monitor's small footprint allows you more room in your workspace for other peripherals. Lightweight and compact, your New Planar LCD Monitor is the perfect solution for users on the go. You can use your New Planar LCD Monitor for everything from making business presentations to playing computer games. The two stereo speakers allow you to further expand your computer's multimedia capabilities by connecting your computer's Audio out port to your New Planar LCD Monitor's Audio in port. If you have a complete full workstation, your New Planar LCD Monitor has the additional feature of an optional wall-mountable stand for added convenience.

The architecture of your New Planar LCD Monitor incorporates an LCD panel that produces a clear display with low radiation emission, limiting health concerns. With its low power consumption, your New Planar LCD Monitor helps you reduce your power bill.

Unpacking

Before you unpack your New Planar LCD Monitor, prepare a suitable workspace for your New Planar LCD Monitor and computer. You need a stable, level and clean surface near a wall outlet. Even though your New Planar LCD Monitor uses very little power, you should put it in a location that allows sufficient airflow to ensure that your New Planar LCD Monitor and your computer do not become too hot. Set up your New Planar LCD Monitor so that the panel does not face a window where sunlight often comes in. The glare caused by sunlight reflecting off your New Planar LCD Monitor's screen will make it difficult to see.



Using a computer for an extended period of time with a poor workstation set-up and incorrect working habits can cause health problems. The science of ergonomics studies the relationship between health and a suitable working environment. There is a section on ergonomics at the end of this chapter. For more information on ergonomics, contact your nearest computer bookstore, or local library. The Internet also has information on this and other subjects.

After you unpack your New Planar LCD Monitor; make sure the following items are included in the box and in good condition:

- LCD Monitor
- Monitor-to-PC signal cable
- 1.5M Stereo Jack Audio Cable
- AC Adapter
- Power cord
- This Planar User's Manual

If you find that any of these items are missing or appear damaged, contact your dealer immediately. Do not throw away the packing material or shipping carton in case you need to ship or store your New Planar LCD Monitor in the future.

Identifying Components

Your New Planar LCD Monitor has been designed to provide easy access to all controls and peripheral ports. The following figures will help you identify your New Planar LCD Monitor's controls and ports.



Your New Planar LCD Monitor — Front View

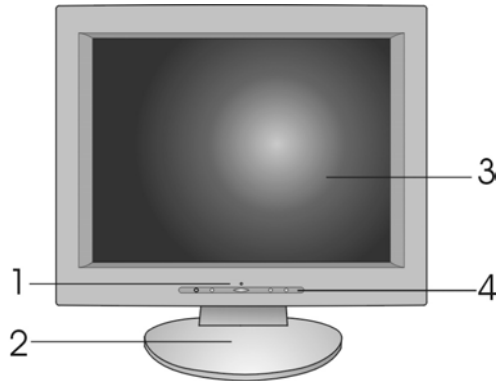

1. **Power-On Indicator**
This LED indicator stays lit when the power is on and when the monitor is receiving a proper video signal. The LED will blink slowly when the LCD monitor is in power saving mode.
2. **Monitor Stand**
The monitor stand supports the LCD monitor.
3. **LCD Screen**
The LCD monitor screen is a 15-inch diagonal, Active Matrix Liquid Crystal Display (AMLCD). The screen is capable of supporting a maximum resolution of 1024 x 768 RGB (XGA).
4. **LCD Monitor Keypad**
Activates and adjusts the monitor's settings through an On Screen Display (OSD).

Your New Planar LCD Monitor — Rear View

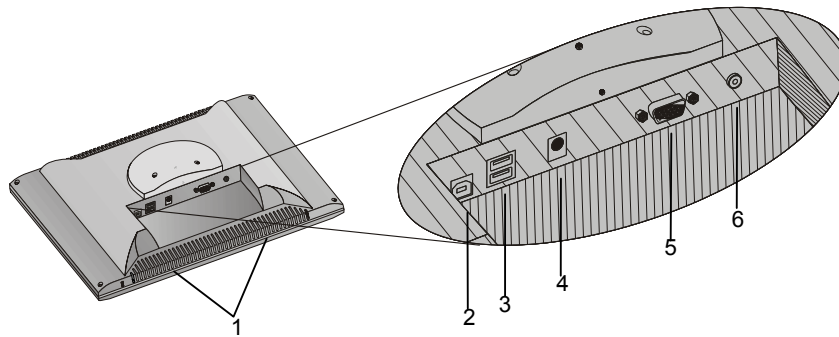

1. **Stereo Speakers (optional)**
The LCD monitor's built-in stereo speakers are located in the bottom of the monitor and face the direction of the desktop.
2. **Upstream USB Port (optional)**
Connect the AC adapter cable to this jack.
3. **Downstream USB Ports (optional)**
The monitor's two downstream USB ports let the LCD monitor function as a USB hub allowing the connection of USB compliant devices. The upstream USB port must be connected to your PC for the downstream ports to function.
4. **DC Power Jack**
Connect the AC adapter cable to this jack.
5. **VGA Cable Connector**
Connect the supplied 1.5m 15-pin D-Sub VGA cable to this connector. The opposite end of the cable is connected to your PC's graphics card.
6. **DC Power Jack**
Connect the AC adapter cable to this jack.



6. **Audio Line-in (optional)**

Connect your PC's line-out to this jack to listen the PC's audio on the LCD monitor's stereo speakers. (You can also connect your CD-ROM's line-out to this jack.)

Adjusting the Monitor's Position

Your LCD monitor's tilting angle can be adjusted in both the landscape and optional portrait mode.

Adjusting the Tilting Angle

The LCD monitor's angle settings range from -5° to 25° in both the landscape and optional portrait viewing modes.

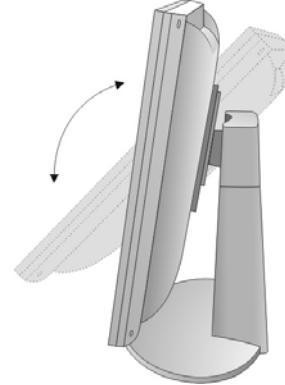

Viewing Orientation

If your LCD monitor supports the portrait mode option, you can adjust the viewing mode from landscape to portrait.

To switch to the portrait mode, tilt the monitor backwards and, using both hands, gently turn it 90° in a clockwise direction.



Forcing the monitor past its maximum extension can result in damage to the monitor.

Connecting AC Power

Refer to the following instructions for connecting AC power to the LCD monitor.

1. Plug the female end of the power cable into the AC-adaptor and the male end of the power cord into a wall socket. The plug on the power cable will vary according to the electrical standard for your area.
2. Plug the adapter power connector into the LCD monitor's DC power jack.

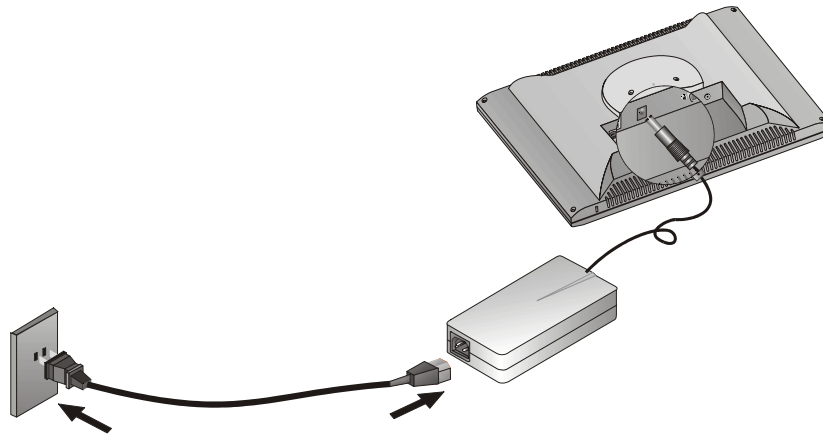

Connecting Video

1. Turn off your PC and the LCD monitor before connecting your LCD monitor to the computer.
2. Loop the 1.5M VGA cable through the hole in the LCD monitor's stand and plug it into the LCD monitor's VGA cable connector.
3. Connect the other end of the VGA cable to the PC's VGA port.
4. Tighten the connecting screws.

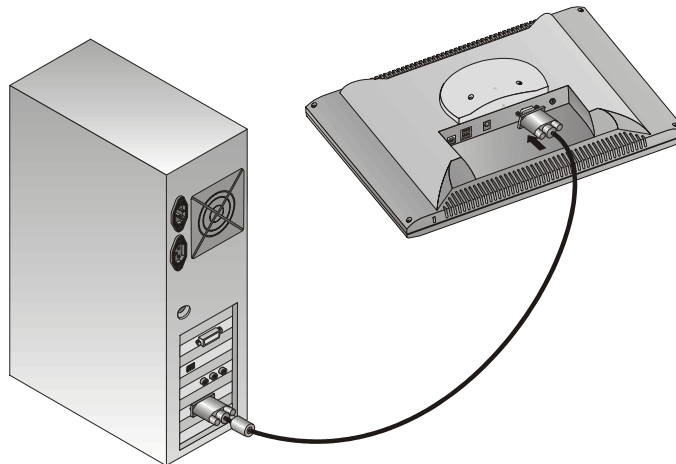

Connecting the Stereo Speakers

Please refer to the following instructions for connecting the LCD monitor's stereo speakers.

1. Connect the 1.5M audio cable to the line-out of your PC's sound card.
2. Connect the other end to the LCD monitor's audio line-in jack.
3. You can adjust the sound volume of the stereo speakers by using the speaker volume control function in the OSD (On-Screen Display).

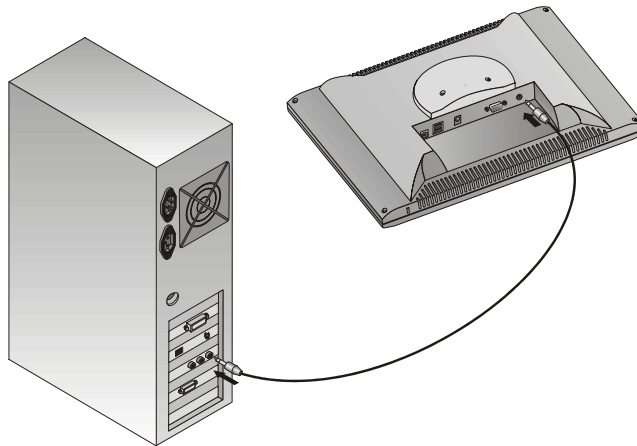

Connecting USB Devices

The following section covers connecting USB devices. The LCD monitor supports an upstream and two downstream USB connections.

Upstream

You can connect the LCD monitor's upstream USB port to your PC's USB port and use the LCD monitor as a USB hub. The following explains how to connect the upstream USB port to your PC:

1. Connect one end of the USB cable to the LCD monitor's upstream USB port.

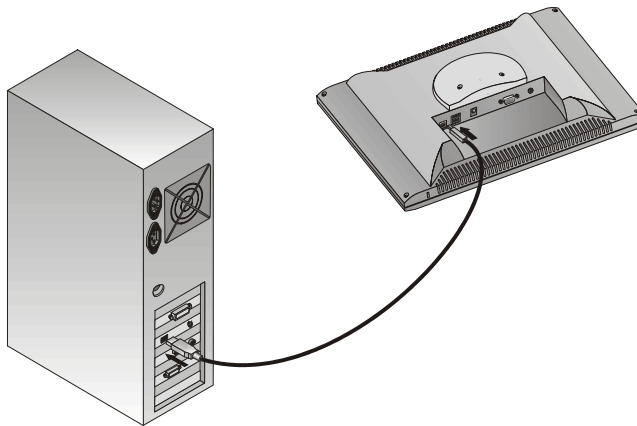

2. Connect the other end to the PC's USB port.

Downstream

The two downstream USB ports connect USB devices, such as USB keyboards, scanners and mice, directly to your LCD monitor.

Connect the USB device cable to one of the LCD monitor's downstream USB ports.

Note: *The upstream USB port must be connected to your PC for the downstream USB ports to function.*

Power Management System

The LCD monitor complies with the VESA DPMS power management proposal. The VESA DPMS proposal provides power saving modes by detecting the horizontal or vertical sync signal. Refer to the Addendum for more information.

When the LCD monitor is in power saving mode or detects an incorrect timing, the monitor screen will be blank and the power LED indicator starts blinking.

The Display Controls

LCD Monitor Control Panel

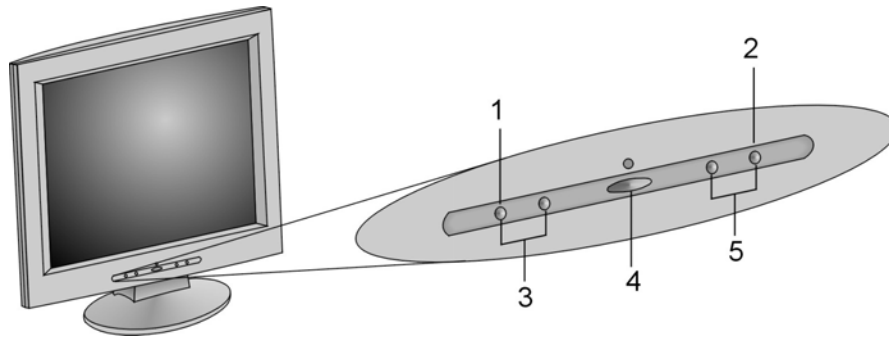

1. **OSD Menu Button**
Press this button to activate the OSD (On-Screen Display) menu. This button is also used as the ◀ Selection button.
2. **Adjust ⊕ Button**
This button allows you to apply settings and enter submenus in the OSD. This button also is used to increase the value of the selected menu item.
3. **◀▶ Function Select Buttons**
These two buttons allow you to select the control functions in the OSD. Press either button to scroll through the main menu and submenu items.
4. **Power Switch**
Push the power switch to turn the monitor on and off. When you shutdown your computer, the monitor will enter power-saving mode. The LED will slowly flash indicating the display is in power saving mode.
5. **⊖ Adjust ⊕ Control Buttons**
The ⊕ button allows you to increase the menu item value.
The ⊖ button allows you to decrease the menu item value.

Adjusting the Display

The LCD monitor features an intuitive, menu-driven, On-Screen Display (OSD). You can access the OSD any time that the PC is powered up. If the PC is in a power saving mode, or is powered down, the OSD is inaccessible.

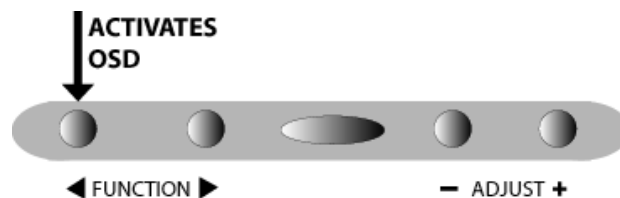

OSD Main Menu

To activate the OSD Main Menu, press the leftmost ◀ Function key. To navigate the topline menu, use either the right ▶ or left ◀ function keys to scroll between the main menu choices.

The option that is currently selected is highlighted in yellow. Each main menu has an associated submenu and is further described.











The 7-topline menus are:





	<p>The Auto Adjust option lets the monitor determine and select the settings that are most appropriate for your system requirements. This function will tune the display to your computers video card.</p>
	<p>The Monitor-Control option allows you to adjust the LCD monitor's display characteristics such as the display's horizontal or vertical position, display phase, display clock, and factory reset. Adjusting these settings should only be necessary if the results from Auto-Adjust function are not satisfactory.</p>
	<p>The OSD-Control option allows you to adjust the position and setting of the monitor's On Screen Display.</p>
	<p>The MISC-Control option allows you to select the desired text language of the OSD, adjust the monitor speaker volume, and to display the current video information being sent to the monitor from your video card.</p>
	<p>The Graphic-Control option allows you to adjust the display contrast, brightness, sharpness, and color settings.</p>
	<p>The Graph/Tex option allows you to switch DOS text resolution from 640x400 and 720x400. This function has no effect within graphic operating systems such as MS Windows™.</p>
	<p>The OSD Exit option closes the On Screen Display.</p>







		<p><u>Auto Adjust Procedure</u></p>
--	--	--



Pressing the Adjust  key while the Auto Adjust topline menu is selected, activates the Auto Adjust procedure. The Auto Adjust procedure takes approximately 2 seconds to complete. Once finished, the OSD menu will disappear after a short time-out period.



		<p align="center"><u>The Monitor- Control Option</u></p>
<p>Pressing the Adjust \oplus key while the Monitor Control icon is selected activates the Monitor Control submenu. Use the \blacktriangleleftFUNCTION\blacktriangleright select buttons to scroll between the submenu items. You should only use this menu item if the results of the Auto Adjust function are not satisfactory.</p>		
	<p>H-Position: Press the \ominus Adjust \oplus buttons to horizontally move the display image to the desired position.</p>	
	<p>V-Position: Press the \ominus Adjust \oplus buttons to vertically move the display image to the desired position.</p>	
	<p>Phase: Press the \ominus Adjust \oplus buttons to fine-tune the displayed image. An improper phase adjustment will result in pixel jitter or display noise.</p>	
	<p>Clock: Press the \ominus Adjust \oplus buttons to stabilize the display clock timing. An improper clock setting will result in wide vertical bands on the display.</p>	
	<p>Reset: Press the Adjust \oplus button to reset the Monitor-Control submenu values to the factory default values.</p>	
	<p>Exit: Press the Adjust \oplus button key to exit the Monitor-Control submenu.</p>	







		<p align="center"><u>OSD - Control Option</u></p>
<p>Pressing the Adjust \oplus key while the OSD Control icon is selected activates the OSD Control submenu. Use the \blacktriangleleftFUNCTION\blacktriangleright select buttons to scroll between the submenu items.</p>		
	<p>OSD-H-Position: Press the \ominus Adjust \oplus buttons to horizontally move the OSD menu.</p>	
	<p>OSD-V-Position: Press the \ominus Adjust \oplus buttons to vertically move the OSD menu.</p>	
	<p>Exit: Press the Adjust \oplus button key to exit the OSD-Control submenu.</p>	



		<p align="center"><u>Misc. - Control Option</u></p>
<p>Pressing the Adjust \oplus key while the Misc Control icon is selected activates the Misc Control submenu. Use the \blacktriangleleftFUNCTION\blacktriangleright select buttons to scroll between the submenu items.</p>		
	<p>Language: Press the \ominus Adjust \oplus buttons to select the desired OSD display language. Languages supported: English, German, French, Spanish, and Italian.</p>	
	<p>Audio Volume: Press the \ominus Adjust \oplus buttons to increase or decrease the volume of the monitor speakers.</p>	
	<p>Information: The Information submenu displays the current resolution, vertical refresh rate, and monitor firmware version.</p>	
	<p>Exit: Press the Adjust \oplus button to exit the Misc-Control submenu.</p>	



		<p align="center"><u>Graphic Control Option</u></p>
---	---	--



Pressing the Adjust \oplus key while the Graphic Control icon is selected activates the Graphic Control submenu. Use the \blacktriangleleft FUNCTION \blacktriangleright select buttons to scroll between the submenu items.

	Contrast: Press the \ominus Adjust \oplus buttons to adjust the difference between the lightest and darkest areas on the display. The contrast level can range from 0 to 63.
	Brightness: Press the \ominus Adjust \oplus buttons to adjust the intensity of the monitor backlight.
	Sharpness: Press the \ominus Adjust \oplus buttons to select the desired sharpness setting.
	Color: Press the \ominus Adjust \oplus buttons to select the desired color temperature setting. The available options are CIE coordinate values 9300°, 6500°. Selecting the USER option, allows for customization of the Red, Green and Blue color coordinates.
	R, G and B: Press the \ominus Adjust \oplus buttons to make individual adjustments to the Red, Green, and Blue coordinates for the customized color temperature. There are 127 levels of adjustments (0 - 127) available. Before adjusting these fields, you must select the User option in the Color submenu.
	Exit: Press the Adjust \oplus button to exit the Graphic-Control submenu.

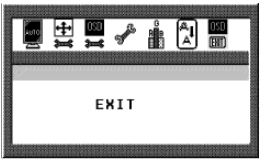
		<u>Graph/Text Option</u>
Pressing the Adjust \oplus key while the Graph/Text icon is selected toggles the DOS resolution between 640x400 and 720x400.		

		<u>OSD Exit</u>
Pressing the Adjust \oplus key while the Exit icon is selected, deactivates the OSD menu.		

Technical Information

Planar TFT LCD Monitor Specifications

Model	Planar WT1503Z	
LCD Panel	15"XGA	
Control Functions Power	Software Power switch with LED indicator (Press to turn off, over 1 sec. to turn on)	
On-Screen Display (OSD)	Main Menu	Submenu
	Auto Adjust	
	Monitor Control	Horizontal Position/Vertical Position/Phase/Clock/Reset/Exit
	OSD Control	OSD Horizontal Position/OSD Vertical Position/Exit
	Misc. Control	Language/Audio Volume/Information/Exit
	Graphic Control	Contrast/Brightness/Sharpness/Color/R/G/B/Exit
	Graph/Text	640 x 400/720 x 400
	OSD Exit	
Display Colors	Dithering 16M	
Response Time(ms) (Rise/Fall)	40 ms typ.	
Contrast Ratio	350:1 typ.	
Brightness	250 cd/m ² typ.	
Pixel Pitch (mm)	0.297 x 0.297	
Viewing Angle	Horizontal: 60°/60° (L/R), Vertical: 45°/60° (U/D)	
Video Interface	VGA Compatible Analog RGB/ Composite Sync.	
Scanning Frequency H/V, Hz	24-62K 50-75	
Number of Factory Preset Mode	22	
Power Management	Meets VESA DPMS	
Power Consumption (ON/OFF, W)	40/4.5Max.	
Dimensions WxHxD mm	408x388x175	
Net Weight (Kg)	4.5	
Power Supply	12.0V/3.75A, 45W Stand-alone AC Adapter (External)	
Options	Other Stands (Wall-mount), Touch Screen, S-Video/Video cable	
Environment	Operating Temperature: 0 to 40° C Relative Humidity: 10% to 90%	
Audio (Two 1 Watt speakers with amplifier)	Yes	
Regulatory	UL, CSA, TÜV/GS, CE Mark, VCCI, T-Mark, FCC B DoC, TCO '99 (optional)	

Supported Timing

Timing for Model WT1503Z (XGA Resolution)

Item	Standards	Resolution	Dot Clock (MHz)	Vertical Scanning Frequency (Hz)	Horizontal Scanning Frequency (kHz)
1	NEC PC98	640x400	25.20	70.15	31.50
2	NEC PC98	640x400	21.05	56.42	24.83
3	MAC 13" mode	640x480	30.24	66.67	35.00
4	MAC 16" mode	832x624	57.28	74.55	49.73
5	MAC 17" mode	1024x768	80.00	75.02	60.24
6	VGA	640x350	25.18	70.09	31.47
7	VGA	640x400	25.18	70.09	31.47
8	VGA	640x480	25.18	59.94	31.47
9	VESA	640x480	31.50	72.81	37.86
10	VESA	640x480	31.50	75.00	37.50
11	VESA	800x600	36.00	56.25	35.16
12	SVGA	800x600	40.00	60.32	37.88
13	VESA	800x600	50.00	72.19	48.08
14	VESA	800x600	49.50	75.00	46.88
15	VGA	720x400	28.32	70.09	31.47
16	XGA	1024x768	65.00	60.00	48.36
17	VESA	1024x768	75.00	70.07	56.48
18	VESA	1024x768	78.75	75.03	60.02
19		1024x768	71.64	66.13	53.96
20	SUN	1024x768	64.13	59.98	48.29
21	SUN	1024x768	74.25	70.04	56.59
22	SUN	1024x768	84.38	77.07	62.04

*Once a mode is optimized, there is no need to make any further adjustment as long as the VGA card remains unchanged.

*Specifications are subject to change without notice.

Troubleshooting

Troubleshooting Procedures

This LCD Monitor was pre-adjusted in the factory with standard VGA timing. Due to output timing differences among various VGA cards, you may initially experience an unstable or unclear display when a new display mode or new VGA card is selected.



This LCD Monitor Supports Multiple VGA Modes. Refer to Appendix B for a listing of the factory-preset modes supported by this LCD Monitor.

PROBLEM: Display is Unclear and Unstable

To stabilize and clarify your display, follow this procedure in this order:

1. It's best to adjust the display on a screen displaying of vertical lines. In Windows, load a wallpaper bitmap that has vertical lines in it. (or you can select the window shut down screen)
2. After you have the wallpaper loaded, open the OSD and select the "Clock" function. Press the top (or bottom) Adjustment Control button and continue pressing the button until you see vertical dark and light lines across the screen.
3. When you can see distinct light and dark vertical bands, stop pressing the Adjustment Control button. Now press the opposite (top or bottom) Adjustment Control button. The vertical dark and light bands will decrease in number. Keep pressing the button until the distinct bands disappear and you have a clear display.
4. Next, press the Function Control button to choose the "Phase" function. The Phase will adjust the horizontal display. Press the top (or bottom) Adjustment Control button and you will see horizontal dark and light lines appear. The number of lines increases as you press the button. Now press the bottom (or top) Adjustment Control button until the lines disappear and you have a clear display.

PROBLEM: There is no LCD Display

If there is no display on the LCD, please perform the following steps:

1. Make sure that the power indicator on your New Planar LCD Monitor is lit, all connections are secure, and the system is running on the correct timing. Refer to the Appendix B for information on timing.
2. Turn off your New Planar LCD Monitor and then turn it back on again. Press the upper Function Control button (refer to Chapter 2) once and then press either the upper or lower Adjustment Control button several times. If there is still no display, press the other Adjustment Control button several times.
3. If step 2 doesn't work, connect your PC system to another external CRT. If your PC System functions properly with a CRT Monitor but it does not function with your New Planar LCD Monitor, and your New Planar LCD Monitor's power LED is blinking, the output timing of the PC's VGA card may be out of the LCD's synchronous range. Please change to an alternate mode listed in Appendix B or replace the VGA card and repeat steps 1 and 2.
4. If the PC doesn't function with the CRT monitor neither, check BIOS to see if there is a dual scan setting under the display mode item. Set the BIOS display mode to *Dual Scan* or *CRT* and try again. If there is still no display, then there may be a problem with your system. Contact technical support.
5. If the power LED is not lit, check to see if the AC power connector is securely connected. Verify that the AC adapter LED is lit. If the AC adapter LED is not lit, please contact your Planar dealer for assistance.