



# Simplicity Series

## USER'S GUIDE

[www.planar.com](http://www.planar.com)

Planar utilizes HDMI® standards in this product.

The terms HDMI, HDMI High-Definition Multimedia Interface, HDMI Trade dress and the HDMI Logos are trademarks or registered trademarks of HDMI Licensing Administrator, Inc.

## Safety Instructions

### Warnings and Precautions

#### KNOW THESE SAFETY SYMBOLS



**CAUTION:** TO REDUCE THE RISK OF ELECTRIC SHOCK, DO NOT REMOVE COVER (OR BACK). NO USER SERVICEABLE PARTS INSIDE. REFER SERVICING TO QUALIFIED SERVICE PERSONNEL.



This symbol indicates high voltage is present inside. It is dangerous to make any kind of contact with any inside part of this product.



This symbol alerts you that important literature concerning operation and maintenance has been included with this product.

**CAUTION:** FCC/CSA regulations state that any unauthorized changes or modifications to this equipment may void the user's authority to operate it.

**CAUTION:** To prevent electric shock, match the wide blade of plug to the wide slot, and fully insert the plug.

TO PREVENT DAMAGE WHICH MAY RESULT IN FIRE OR ELECTRIC SHOCK HAZARD, DO NOT EXPOSE THIS APPLIANCE TO RAIN OR MOISTURE.

The Socket-outlet should be installed near the apparatus and be easily accessible.



**Read and follow these instructions when connecting and using your Public Information Display:**

- Unplug the display if you are not going to use it for an extensive period of time.
- Unplug the display if you need to clean it with a slightly damp cloth. The screen may be wiped with a dry cloth when the power is off. However, never use alcohol, solvents or ammonia-based liquids.
- Consult a service technician if the display does not operate normally when you have followed the instructions in this manual.
- The casing cover should be opened only by qualified service personnel.
- Keep the display out of direct sunlight and away from stoves or any other heat sources.
- Remove any object that could fall into the vents or prevent proper cooling of the display's electronics.
- Do not block the ventilation holes on the cabinet.
- Keep the display dry. To avoid electric shock, do not expose it to rain or excessive moisture.
- If turning off the display by detaching the power cable, wait for 6 seconds before re-attaching the power cable for normal operation.
- To avoid the risk of shock or permanent damage to the set do not expose the display to rain or excessive moisture.
- When positioning the display, make sure the power plug and outlet are easily accessible.
- **IMPORTANT:** Always activate a screen saver program during your application. If a still image in high contrast remains on the screen for an extended period of time, it may leave an 'after-image' or 'ghost image' on the front of the screen. This is a well-known phenomenon that is caused by the shortcomings inherent in LCD technology. In most cases the afterimage will disappear gradually over a period of time after the power has been switched off. Be aware that the after-image symptom cannot be repaired and is not covered under warranty.

## Important Safety Instructions

1. Read these instructions.
2. Keep these instructions.
3. Heed all warnings.
4. Follow all instructions.
5. Do not use this apparatus near water.
6. Clean only with dry cloth.
7. Do not block any ventilation openings. Install in accordance with the manufacturer's instructions.
8. Do not install near any heat sources such as radiators, heat registers, stoves, or other apparatus (including amplifiers) that produce heat.
9. Do not defeat the safety purpose of the polarized or grounding-type plug. A polarized plug has two blades with one wider than the other. A grounding type plug has two blades and a third grounding prong. The wide blade or the third prong are provided for your safety. If the provided plug does not fit into your outlet, consult an electrician for replacement of the obsolete outlet.
10. Protect the power cord from being walked on or pinched particularly at plugs, convenience receptacles, and the point where they exit from the apparatus.
11. Only use attachments/accessories specified by the manufacturer.
12. Use only with the cart, stand, tripod, bracket, or table specified by the manufacturer, or sold with the apparatus. When a cart is used, use caution when moving the cart/apparatus combination to avoid injury from tip-over.
13. Unplug this apparatus during lightning storms or when unused for long periods of time.
14. Refer all servicing to qualified service personnel. Servicing is required when the apparatus has been damaged in any way, such as power-supply cord or plug is damaged, liquid has been spilled or objects have fallen into the apparatus, the apparatus has been exposed to rain or moisture, does not operate normally, or has been dropped.



**WARNING:** To prevent injury, this apparatus must be securely attached to the floor/wall in accordance with the installation instructions.

**CAUTION:** These servicing instructions are for use by qualified service personnel only. To reduce the risk of electric shock, do not perform any servicing other than that contained in the operating instructions unless you are qualified to do so.

**CAUTION:** Excessive sound pressure from earphones and headphones can cause hearing loss. Adjustment of the equalizer to maximum increases the earphone and headphone output voltage and the sound pressure level. Therefore, to protect your hearing, adjust the equalizer to an appropriate level.

**For UL/CUL application:** For use only with UL Listed Wall Mount Bracket with minimum weight/load:

	Minimum weight/load (kg)
SL3250	19.8
SL4250	35.7
SL4650	41.1
SL5550	63.6

**For CB application:** The equipment and its associated mounting means still remain secure during the test:

	Unit Weight (kg)	VESA Size (mm)	Mounting Screws (X=Thickness of wall-mount plate)
SL3250	6.6	200 × 100	M6 × (16 + X)
SL4250	11.9	400 × 400	M6 × (20 + X)
SL4650	13.7	400 × 400	M6 × (20 + X)
SL5550	21.2	400 × 400	M6 × (24 + X)

**WARNING:** TO REDUCE THE RISK OF FIRE OR ELECTRIC SHOCK, DO NOT EXPOSE THIS APPARATUS TO RAIN OR MOISTURE.

**WARNING:** Apparatus shall not be exposed to dripping or splashing and no objects filled with liquids, such as vases, shall be placed on the apparatus.

**WARNING:** The batteries (batteries installed) shall not be exposed to excessive heat such as sunshine, fire or the like.

**WARNING:** The mains plug or appliance coupler is used as the disconnect device, the disconnect device shall remain readily operable.

**WARNING:** To prevent the spread of fire, keep candles or other open flames away from this product at all times.



## Regulatory Information:

Products: SL3250, SL4250, SL4650 and SL5550; Regulatory Models: DS323QBT, DS423QBT, DS463QBT and DS553QBT.

## CE Declaration of Conformity

We declare under our responsibility that the product is in conformity with the following standards:

- EN60065:2002+A1:2006+A11:2008+A2:2010+A12:2011 (Safety requirement of Audio, video and similar electronic apparatus)
- EN55022:2010 (Radio Disturbance requirement of Information Technology Equipment)
- EN55024:2010 (Immunity requirement of Information Technology Equipment)
- EN61000-3-2:2006 +A1:2009+A2:2009 (Limits for Harmonic Current Emission)
- EN61000-3-3:2008 (Limitation of Voltage Fluctuation and Flicker)
- EN 50581:2012 (Technical documentation for the assessment of electrical and electronic products with respect to the restriction of hazardous substances)

following provisions of directives applicable:

- 2006/95/EC (Low Voltage Directive)
- 2004/108/EC (EMC Directive)
- 2009/125/EC (ErP Directive, EC No. 1275/2008, 642/2009 Implementing Directive for Standby and Off mode power consumption)
- 93/68/EEC (Amendment of EMC and Low Voltage Directive) and is produced by a manufacturing organization on ISO9000 level.
- 2011/65/EU (RoHS 2 Directive)

## Federal Communications Commission (FCC) Notice (U.S. Only)



This equipment has been tested and found to comply with the limits for a Class B digital device, pursuant to Part 15 of the FCC Rules. These limits are designed to provide reasonable protection against harmful interference when the equipment is operated in a commercial environment. This equipment generates, uses and can radiate radio frequency energy and, if not installed and used in accordance with the instructions manual, may cause harmful interference to radio communications. Operation of this equipment in a residential area is likely to cause harmful interference in which case the user will be required to correct the interference at his own expense.



Changes or modifications not expressly approved by the party responsible for compliance could void the user's authority to operate the equipment.

Use only an RF shielded cable that was supplied with the display when connecting this display to a computer device.

To prevent damage which may result in fire or shock hazard, do not expose this appliance to rain or excessive moisture.

**THIS CLASS B DIGITAL APPARATUS MEETS ALL REQUIREMENTS OF THE CANADIAN INTERFERENCE-CAUSING EQUIPMENT REGULATIONS.**



This device complies with Part 15 of the FCC Rules. Operation is subject to the following two conditions: (1) this device may not cause harmful interference, and (2) this device must accept any interference received, including interference that may cause undesired operation.

## End-of-Life Disposal

Your new Public Information Display contains materials that can be recycled and reused. Specialized companies can recycle your product to increase the amount of reusable materials and to minimize the amount to be disposed of.

Please find out about the local regulations on how to dispose of your old display from your local dealer.

### (For customers in Canada and U.S.A.)

Dispose of in accordance to local-state and federal regulations. For additional information on recycling contact [www.eia.org](http://www.eia.org) (Consumer Education Initiative)

## Waste Electrical and Electronic Equipment- WEEE

### Attention users in European Union private households



This marking on the product or on its packaging illustrates that, under European Directive 2002/96/EC governing used electrical and electronic appliances, this product may not be disposed of with normal household waste. You are responsible for disposal of this equipment through a designated waste electrical and electronic equipment collection. To determine the locations for dropping off such waste electrical and electronic, contact your local government office, the waste disposal organization that serves your household or the store at which you purchased the product.

### End of Life Directives-Recycling



Your new Public Information Display contains several materials that can be recycled for new users.

Please dispose of according to all Local, State, and Federal laws.

# Table Of Contents

<b>1. Unpacking and Installation</b> .....	<b>1</b>
1.1. Unpacking .....	1
1.2. Package Contents .....	1
1.3. Installation Notes.....	1
1.4. Mounting on a Wall.....	2
1.5. Cable Management.....	3
1.6. Orientating in Portrait .....	3
<b>2. Parts and Functions</b> .....	<b>4</b>
2.1. Control Panel .....	4
2.2. Input/Output Terminals .....	6
2.3. Remote Control .....	8
2.3.1. General functions.....	8
2.3.2. Inserting batteries in the remote control .....	9
2.3.3. Handling the remote control....	9
2.3.4. Operating range of the remote control .....	9
2.4. RS232 Control.....	10
2.5. LAN control .....	10
<b>3. Connection</b> .....	<b>11</b>
3.1. Connecting External Equipments....	11
3.2. Connecting Multiple Displays .....	12
3.2.1. RS232 Loop Through .....	12
3.2.2. IR Loop Through .....	12
3.3. IR Pass-through Connection .....	13
3.4. Connecting Display to the Network. 13	
3.5. Connecting Display to a Wireless Device .....	14
<b>4. Operation</b> .....	<b>15</b>
4.1. Watch the Connected Video Source	15
4.2. Change Picture Format.....	15
4.3. Play Multimedia Files .....	15
4.3.1. Play files from computer .....	15
4.3.2. Play multimedia files from USB device.....	15
4.3.3. Play files from wireless device.....	16
4.4. Play options.....	16
4.4.1. Playing music files .....	16
4.4.2. Playing movie files .....	17
4.4.3. Playing photo files.....	17
<b>5. Change your settings</b> .....	<b>18</b>
5.1. Settings .....	18
5.1.1. Picture menu.....	18
5.1.2. Sound menu.....	19
5.1.3. General settings menu.....	19
5.2. Network Settings .....	20
<b>6. Input mode</b> .....	<b>21</b>
<b>7. Cleaning and Troubleshooting</b> .....	<b>22</b>
7.1. Cleaning .....	22
7.2. Troubleshooting.....	23
<b>8. Technical Specifications</b> .....	<b>24</b>
8.1. SL3250 .....	24
8.2. SL4250 .....	25
8.3. SL4650 .....	26
8.4. SL5550 .....	27

# 1. Unpacking and Installation

## 1.1. Unpacking

- This product is packed in a carton, together with the standard accessories.
- Any other optional accessories will be packed separately.
- Due to the size and weight of this display it is recommended for two people to move it.
- After opening the carton, ensure that the contents are complete and in good condition.

## 1.2. Package Contents

Please verify that you received the following items with your package content:

- LCD display
- User manual
- Remote control with AAA batteries
- Power cord (1.8 m)
- VGA cable (1.8 m)
- RS232 cable (1.8 m)
- Cable Clamps (2)

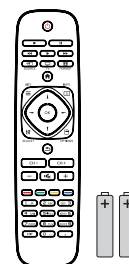
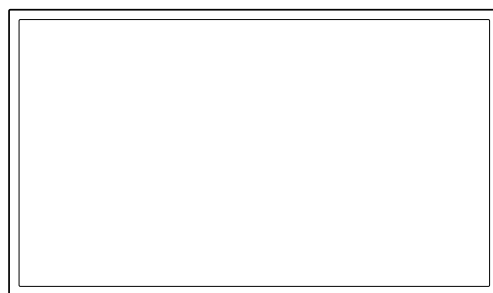

Remote Control  
and AAA Batteries



Power Cord

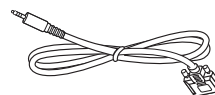

RS232 Cable

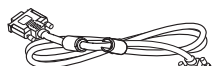

VGA Cable



Quick Start Guide

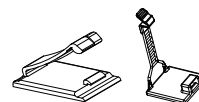

Cable clamps (2)

### NOTES:

- For all other regions, apply a power cord that conforms to the AC voltage of the power socket and has been approved by and complies with the safety regulations of the particular country.
- Keep the package box and packing material for shipping the display.

## 1.3. Installation Notes

- Due to the high power consumption, always use the plug exclusively designed for this product. If an extended line is required, please consult your service agent.
- The product should be installed on a flat surface to avoid tipping. The distance between the back of the product and the wall should be maintained for proper ventilation. Avoid installing the product in the kitchen, bathroom or any other places with high humidity so as not to shorten the service life of the electronic components.
- The product can normally operate only under 2000 m in altitude. In installations at altitudes above 2000 m, some abnormalities may be experienced.

### 1.4. Mounting on a Wall

To mount this display to a wall, you will have to obtain a standard wall-mounting kit. We recommend using a mounting interface that complies with UL1678 standard in North America.

**SL3250:**

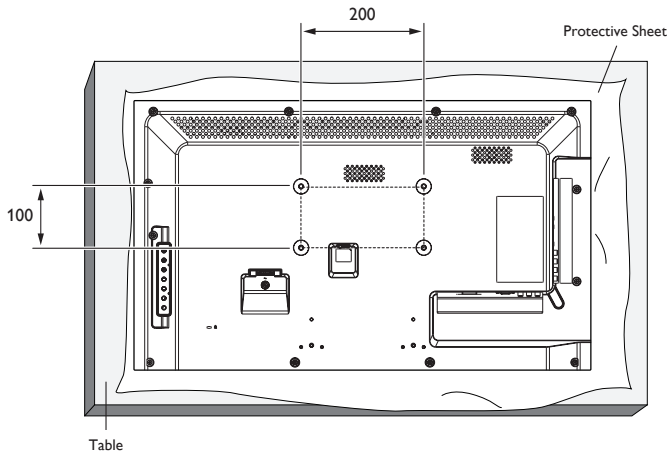

**SL4250:**

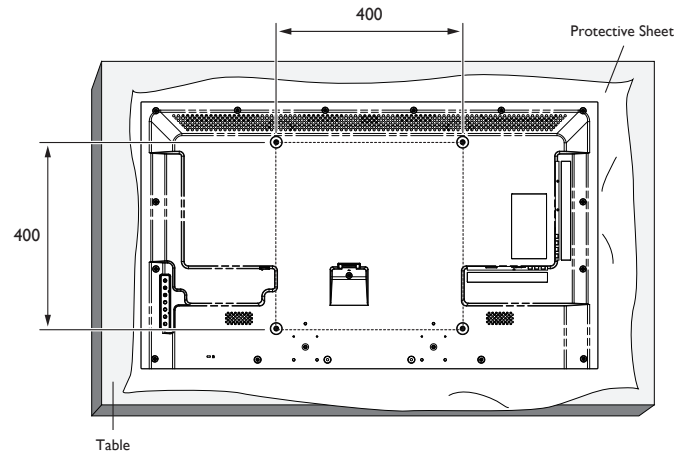

**SL4650:**

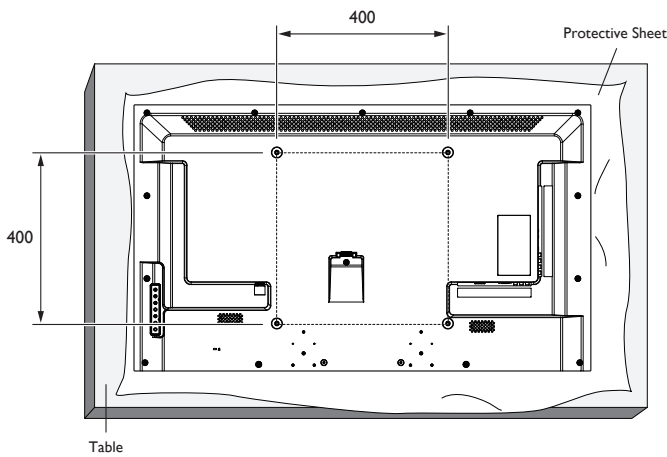

**SL5550:**

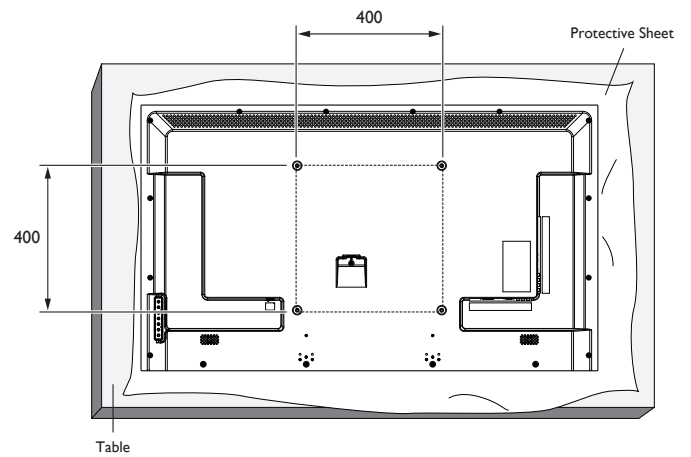

1. Lay a protective sheet on a table, which was wrapped around the display when it was packaged, beneath the screen surface so as not to scratch the screen face.
2. Ensure you have all accessories for mounting this display.
3. Follow the instructions that come with the base mounting kit. Failure to follow correct mounting procedures could result in damage to the equipment or injury to the user or installer. Product warranty does not cover damage caused by improper installation.
4. For the wall-mounting kit, use mounting screws and tighten them securely:

	VESA Size (mm)	Mounting Screws (X=Thickness of wall-mount plate)
SL3250	200 × 100	M6 × (16 + X)
SL4250	400 × 400	M6 × (20 + X)
SL4650	400 × 400	M6 × (20 + X)
SL5550	400 × 400	M6 × (24 + X)



**Caution:**

To prevent the display from falling:

- To lessen the probability of injury and damage resulting from fall of the display in case of earthquake or other natural disaster, be sure to consult the bracket manufacturer for installation location.

**Ventilation Requirements for enclosure locating**

To allow heat to disperse, leave space between surrounding objects as shown in the diagram below.

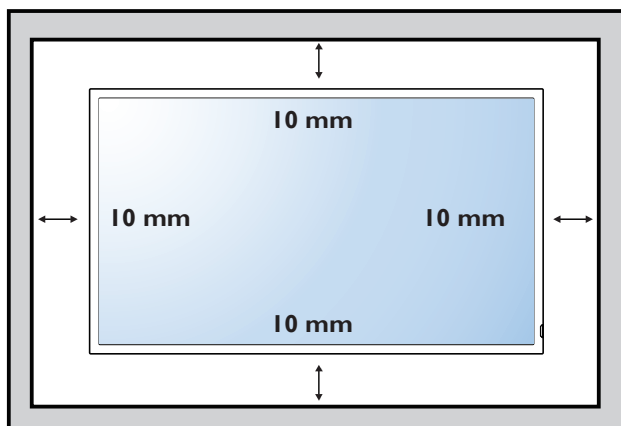
**1.5. Cable Management**

To use cable clamps for cable management.

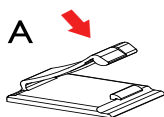
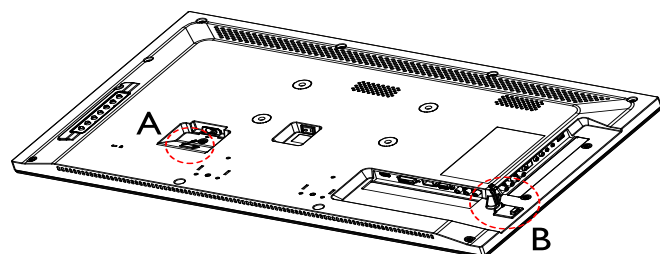

Use cable clamp A to lock the power cord

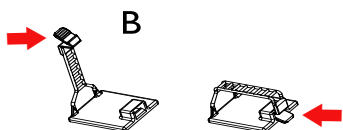

Use cable clamp B to arrange the wires / cables in side terminals

**1.6. Orientating in Portrait**

When using the display in the portrait position and looking at the front of the display,

it should be rotated clockwise so that the IR sensor window is on the bottom of the display. This will allow for proper ventilation.

## 2. Parts and Functions

### 2.1. Control Panel

SL3250:

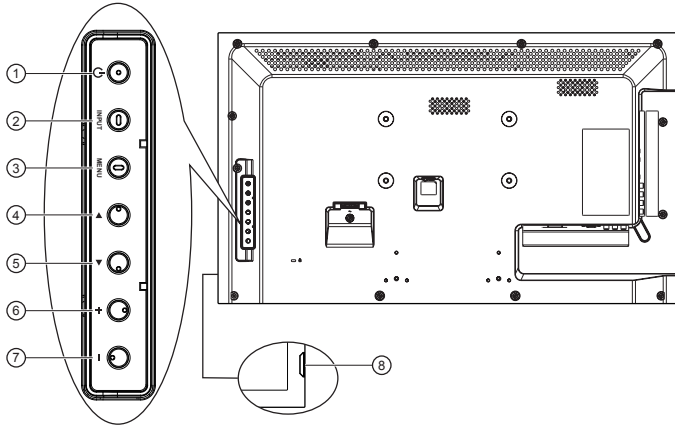

SL4250:

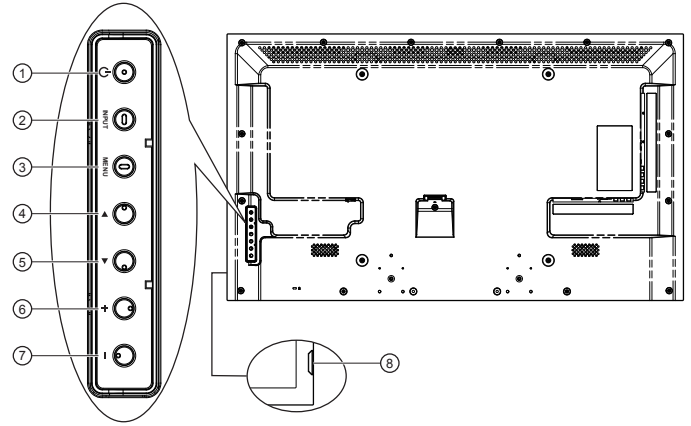

SL4650:

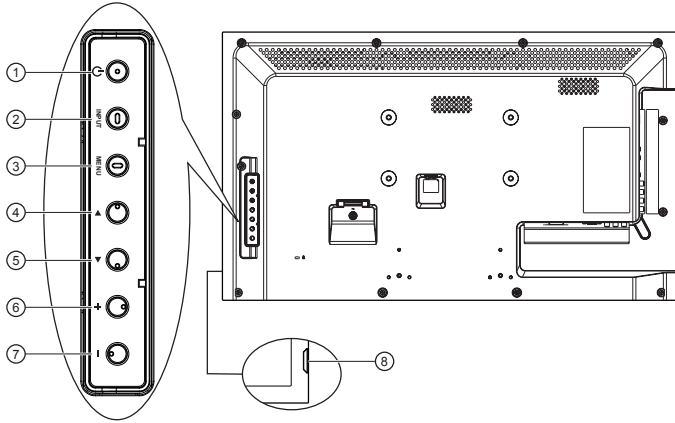

SL5550:

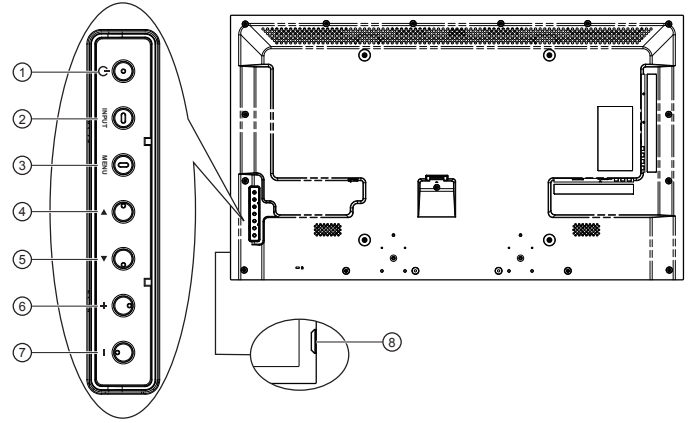

**① [POWER] button**

Press to switch the display on or off.

**② [INPUT] button**

Press to select input source.

**③ [MENU] button**

Press to access the OSD menu.

**④ [▲] button**

Press to move the highlight bar right to selected item while OSD menu is on.

**⑤ [▼] button**

Press to move the highlight bar left to deselected item while OSD menu is on.

**⑥ [+] button**

Press to move the highlight bar up or increase the adjustment while OSD menu is on, or to increase the audio output level while OSD menu is off.

**⑦ [-] button**

Press to move the highlight bar down or decrease the adjustment while OSD menu is on, or to decrease the audio output level while OSD menu is off.

**⑧ Remote control sensor and power status indicator**

- Receives command signals from the remote control.
  - Light off when the display is turned on
  - Lights red when this display is in standby mode
  - Lights off when the main power of this display is turned off

## 2.2. Input/Output Terminals

SL3250:

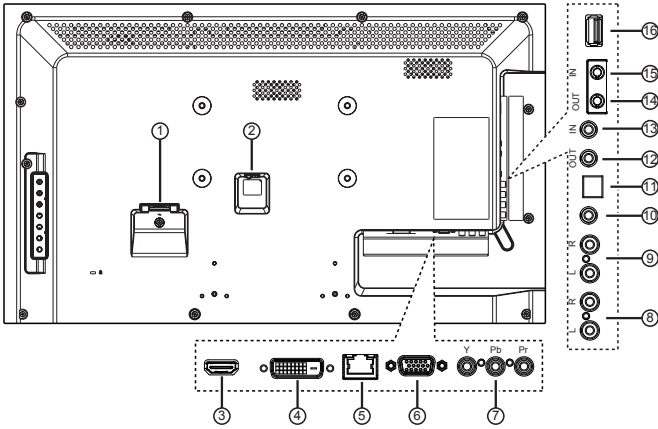

SL4250:

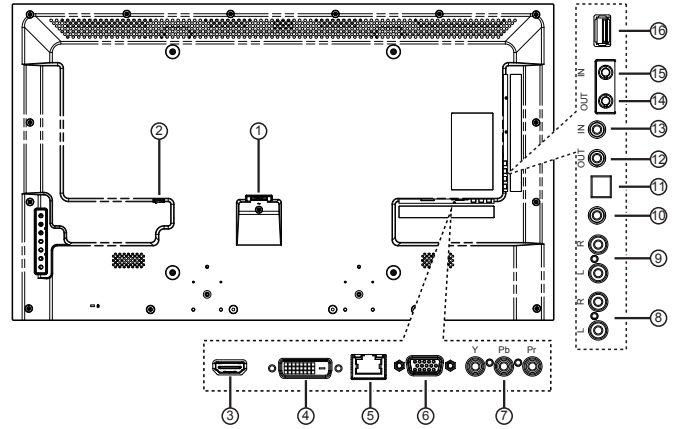

SL4650:

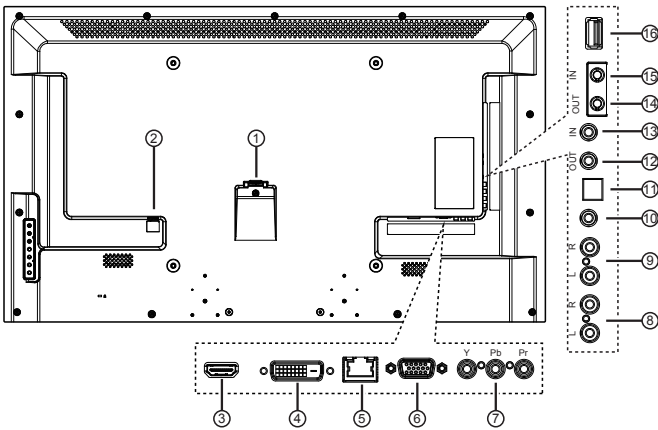

SL5550:

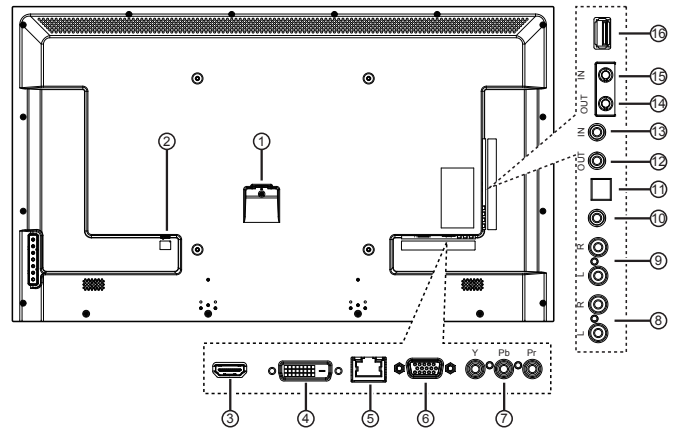

- 
- ① **AC IN**  
AC power input.
  - ② **MAIN POWER SWITCH**  
Main power on/off switch.
  - ③ **HDMI IN**  
HDMI video/audio input.
  - ④ **DVI IN**  
DVI-D video input.
  - ⑤ **RJ-45**  
LAN control function for the use of remote control signal from control center.
  - ⑥ **VGA IN (D-Sub)**  
VGA video input.
  - ⑦ **COMPONENT IN (RCA)**  
Component YPbPr video source input.
  - ⑧ **AUDIO IN (RCA)**  
Audio input from external AV device.
  - ⑨ **AUDIO OUT (RCA)**  
Audio signal output to connect your external AV device.
  - ⑩ **AUDIO IN (3.5mm)**  
Audio input from your PC.
  - ⑪ **SPDIF OUT**  
Digital audio signal output to connect your external AV device.
  - ⑫ **IR OUT / ⑬ IR IN (3.5 mm)**  
IR signal output/input for the loop-through function.
- NOTES:**
- This display's remote control sensor will stop working if the jack [IR IN] is connected.
  - To remotely control your A/V device via this display, refer to page 13 for **IR Pass Through** connection.
- ⑭ **RS232C OUT / ⑮ RS232C IN (2.5 mm)**  
RS232C network output/input for the loop-through function.
  - ⑯ **USB PORT**  
Connect your USB storage device.

## 2.3. Remote Control

### 2.3.1. General functions

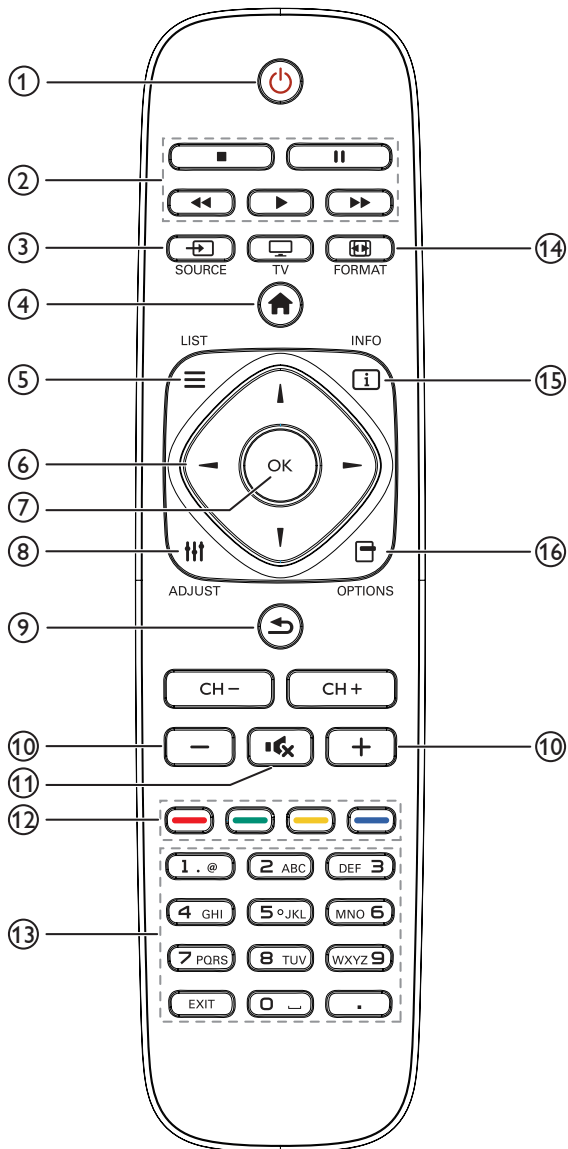

- ⑦ **OK button**  
Confirm an entry or selection.
- ⑧ **ADJUST button**  
Access currently available options, picture and sound menus.
- ⑨ **BACK button**  
Return to the previous menu page or exit from the previous function.
- ⑩ **VOLUME button**  
Adjust volume.
- ⑪ **MUTE button**  
Press to turn the mute function on/off.
- ⑫ **COLOR buttons**  
Select tasks or options for media player.
- ⑬ **NUMERIC buttons**  
Enter text for network setting.
- ⑭ **FORMAT button**  
Change picture format.
- ⑮ **INFO button**  
Display information about current activity.
- ⑯ **OPTIONS button**  
Access currently available options, picture and sound menus.

- ① **POWER button**  
Switch this display on or off.
- ② **PLAY buttons**  
Control playback of media files.
- ③ **SOURCE button**  
Select input source. Press [←] or [→] button to select from **USB, Network, HDMI, DVI, YPbPr, AV, or VGA**. Press [OK] button to confirm and exit.
- ④ **HOME button**  
Access the OSD menu.
- ⑤ **LIST**  
Not applicable.
- ⑥ **NAVIGATION buttons**  
Navigate through menus and select items.

### 2.3.2. Inserting batteries in the remote control

The remote control is powered by two 1.5V AAA batteries.

To install or replace batteries:

1. Press and then slide the cover to open it.
2. Align the batteries according to the (+) and (-) indications inside the battery compartment.
3. Replace the cover.

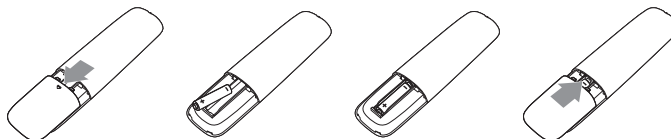

#### Caution:

The incorrect use of batteries can result in leaks or bursting. Be sure to follow these instructions:

- Place “AAA” batteries matching the (+) and (-) signs on each battery to the (+) and (-) signs of the battery compartment.
- Do not mix battery types.
- Do not combine new batteries with used ones. It causes shorter life or leakage of batteries.
- Remove the dead batteries immediately to prevent them from liquid leaking in the battery compartment. Don't touch exposed battery acid, as it can damage your skin.

**NOTE:** If you do not intend to use the remote control for a long period, remove the batteries.

### 2.3.3. Handling the remote control

- Do not subject to strong shock.
- Do not allow water or other liquid to splash the remote control. If the remote control gets wet, wipe it dry immediately.
- Avoid exposure to heat and steam.
- Other than to install the batteries, do not open the remote control.

### 2.3.4. Operating range of the remote control

Point the front of the remote control toward this display's remote control sensor when pressing a button.

Use the remote control within a distance of less than 10m/33ft from this display's sensor, and a horizontal and vertical angle of less than 30 degrees.

**NOTE:** The remote control may not function properly when the remote control sensor on this display is under direct sunlight or strong illumination, or when there is an obstacle in the path of signal transmission.

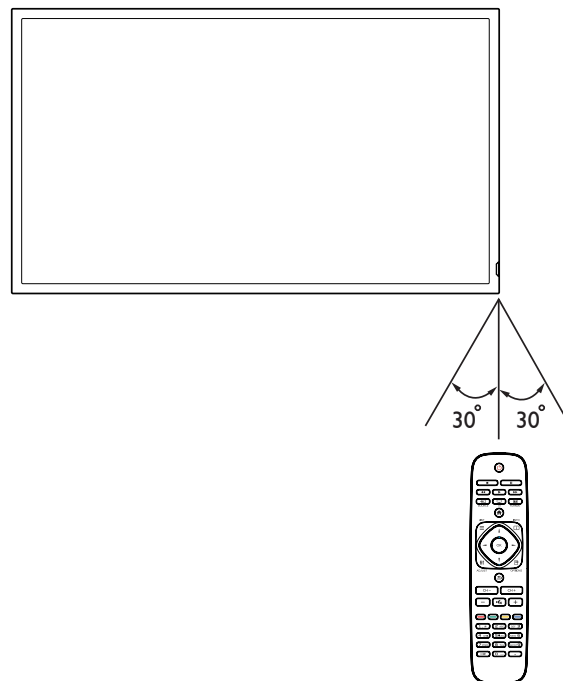

## 2.4. RS232 Control

See [www.planar.com](http://www.planar.com) for Simplicity RS-232 manual.

## 2.5. LAN control

The Simplicity Series supports extending access to the RS232 commands over a network connection. Below are the steps to follow for controlling the display over LAN through the RJ45 connector:

1. Connect display & PC to hub or connect display to PC with LAN cable directly.
2. SET display IP address

Step 1: In Network Settings menu, select "Network configuration"->"Static IP"

Step 2: Then go to "Static IP configuration" and enter the pertinent information.

Step 3: "View network settings" to check IP address

3. Commands are sent via TCP connection to port 5000. The commands are the same as for the RS232 port (see Simplicity RS-232 manual on [www.planar.com](http://www.planar.com)).

4. You can test commands using any TCP utility program that allows you to enter binary data in hexadecimal format. (Note: Contact Planar Technical Support for recommended programs.)



### 3. Connection

Note: VGA cable and power cord included with display. All other cables to be purchased separately.

#### 3.1. Connecting External Equipments

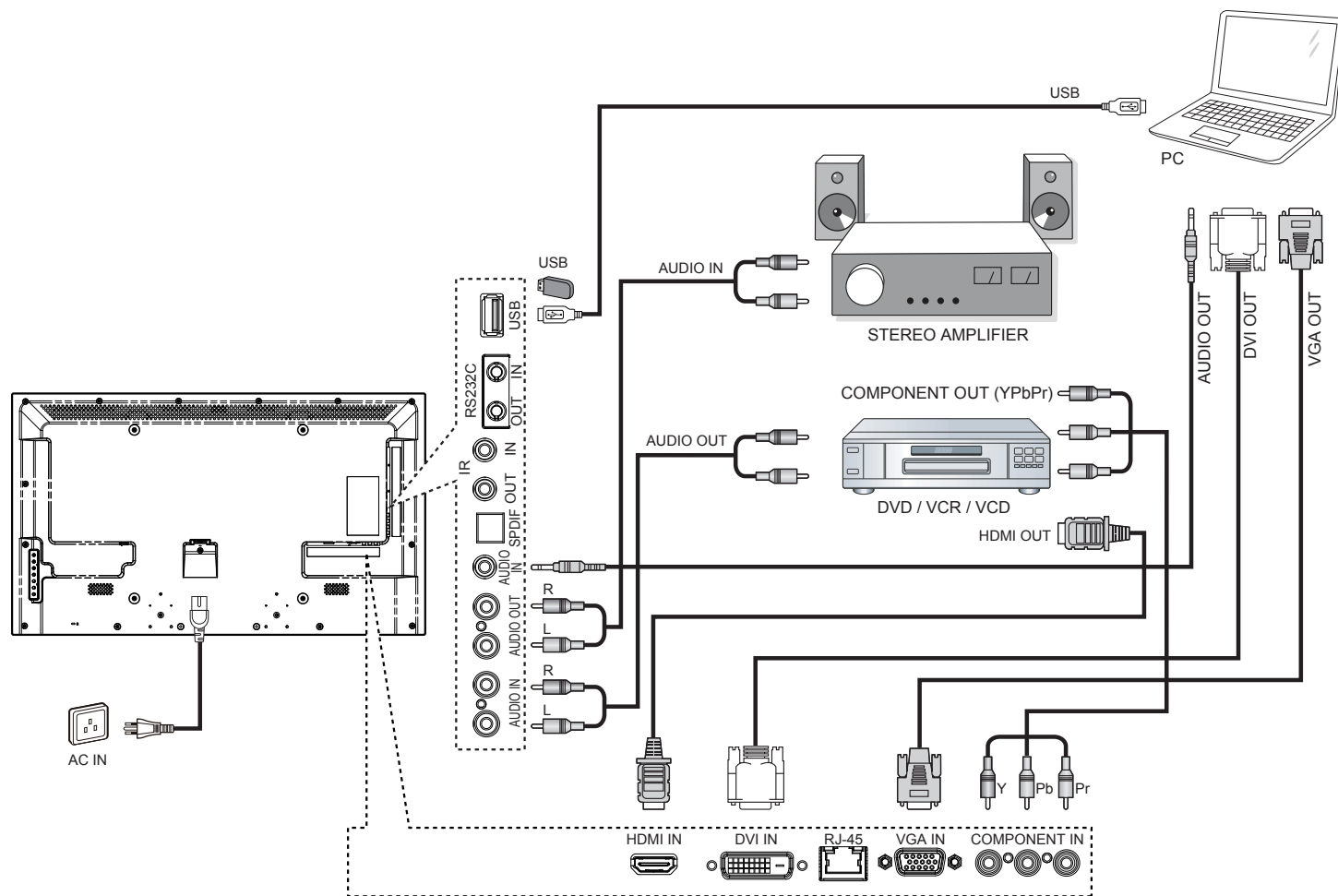

## 3.2. Connecting Multiple Displays

### 3.2.1. RS232 Loop Through

You can control multiple displays at one time through RS232. Loop through cables are not included with the display and would need to be purchased separately.

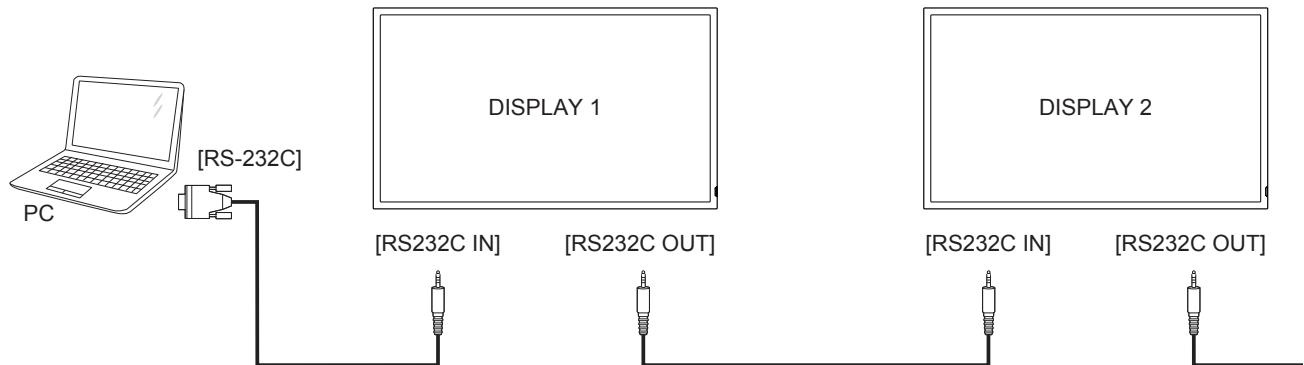

### 3.2.2. IR Loop Through

You can control multiple displays at one time with one remote using the IR in/out connectors on the display. External IR Receivers and IR loop through cables are not included with the display and would need to be purchased separately.

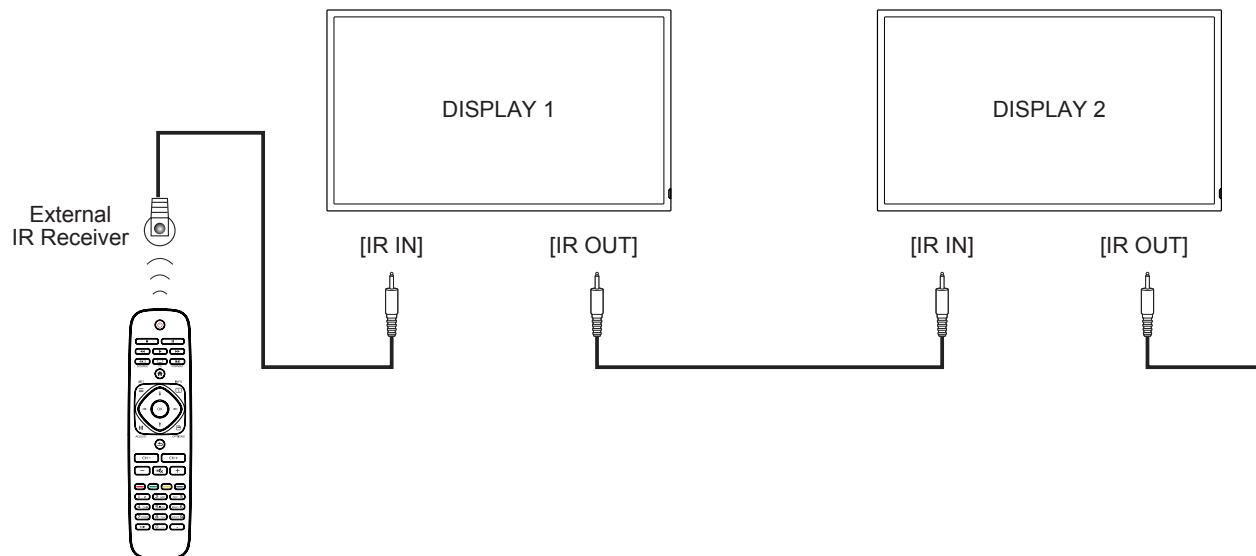

**NOTE:** This display's remote control sensor will stop working if the [IR IN] is connected.

### 3.3. IR Pass-through Connection

You can use your display remote to control one of your sources if they are connected by IR loop through cables. These cables are not included with the display and would need to be purchased separately.

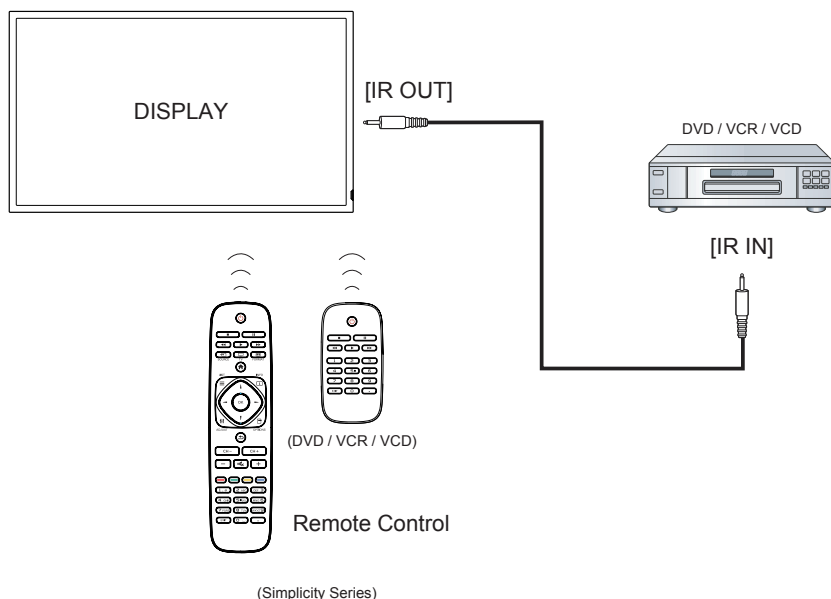

### 3.4. Connecting Display to the Network

If you connect the display to a network, you can play photos, videos, and music from your computer.

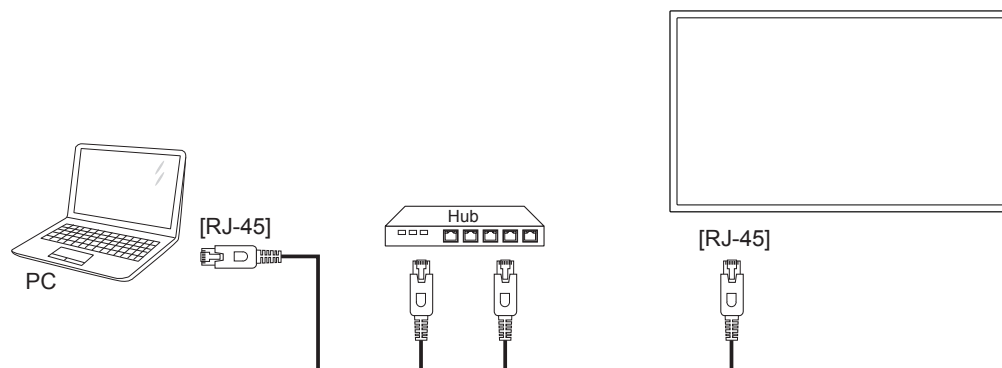

#### To set up the connection::

1. Connect the display with a LAN cable connected to a hub or router on your network.
2. Press **HOME** button to display the OSD menu.
3. Press **▲** or **▼** button to select the menu item {Network setting}. Press **OK** button to enter its submenu.
4. Go to network configuration and select DHCP & Auto IP or Static IP. If you select Static IP, you will need to enter the information in the Static IP Configuration menu.
5. Connect the PC with a LAN cable connected to the Ethernet using a hub or router. Identify the network on your computer.
6. Confirm that a media server is running on your computer, such as Windows Media Player (11 or higher) for PC or Twonky for Mac.
7. Make sure you have the appropriate settings on your computer firewall to allow you to run the media server through the network.
8. See Play Multimedia Files (Page 15) for more detail on playing content.

**Manage security to files using standard Windows and Mac privacy features..**

### **3.5. Connecting Display to a Wireless Device**

If you connect the display to a wireless router, you can access files from a wireless device, like a smartphone, tablet, or laptop. For best results, we recommend using a device with built-in DLNA functionality. Do not connect multiple device at the same time.

To set up the connection:



1. Connect your wireless device to the internet to download app that are designed to send media via DLNA (Examples: iMediashare, ArkMC)
2. Connect your device to the wireless router.
3. Enable network sharing on your device. This varies for different phone/tablet models.
4. Enable DMR (Digital Media Renderer) feature on the display under Network Settings. Got to Digital Media Renderer submenu and select ON.
5. See Play Multimedia Files (Page 15) for more detail on playing content.

## 4. Operation

**NOTE:** The control button described in this section is mainly on the remote control unless specified otherwise.

### 4.1. Watch the Connected Video Source



See page 13 for external equipments connection.

1. Press  **SOURCE** button.
2. Press  or  button to select a device, then press **OK** button.

### 4.2. Change Picture Format

You can change the picture format to suit the video source. Each video source has its available picture formats.

The available picture formats depend on the video source:

1. Press  **FORMAT** button.
2. Press  or  button to select a picture format, then press **OK** button.
  - **{Auto zoom}**: Enlarge the picture to fill the screen. Recommended for minimal screen distortion but not for **HD** or **PC**.
  - **{Movie expand 16:9}**: Scale 4:3 format to 16:9. Not recommended for **HD** or **PC**.
  - **{Wide screen}**: Shows widescreen format content unstretched. Not recommended for **HD** or **PC**.
  - **{Unscaled}**: Provide maximum detail for **PC**. Only available when **PC** mode is selected in the **{Picture}** menu.
  - **{4:3}**: Display the classic 4:3 format.

### 4.3. Play Multimedia Files

You can play videos, photos, and music on your display from:

- Your computer connected to your network.
- A USB device connected to the display.
- A device connected wirelessly to a router connected to the display

#### Supported file system:

- FAT32

#### Supported file format:

- **Music**: MP3, WMA, M4A, AAC, AC3
- **Movie**: AVI, MP4, MOV, MPG/MPEG
- **Photo**: JPEG, BMP, GIF

#### 4.3.1. Play files from computer

1. Connect your display to the network (see page 13)
2. Confirm that the computer, hub or router, and display are turned on and connected.
3. Switch on media sharing on your computer using the media server. For more information on how to set up the media server, refer to the website of the media server.
4. Press the **SOURCE** button on the remote and Select **Network**.
5. Select a file from the content browser, then press **OK** button to start playing.

6. Use the remote control to control the media files on the display.

Tips:





- Select the top bar to filter your files by type.
- Select [**Sort**] to arrange the files by album name, artist, or other fields.
- To clear the list of offline media servers, press  **OPTIONS** button, then select [**Clear offline servers**] and press **OK** button.

#### 4.3.2. Play multimedia files from USB device

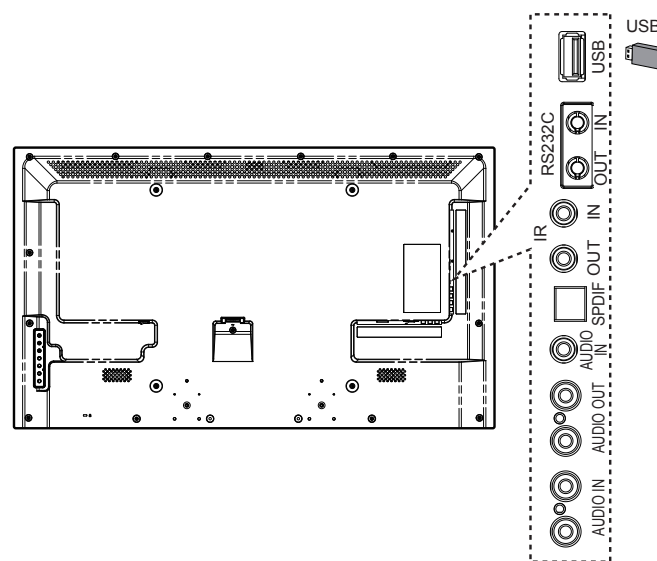





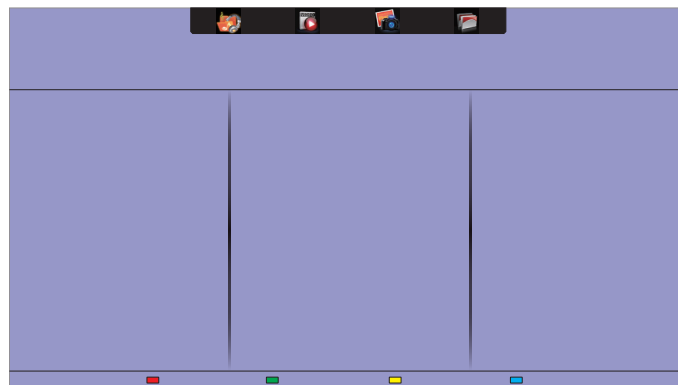

This display can play music, movie, or photo files from your USB device.

1. Connect your USB device to the USB port on this display.



2. Press  **SOURCE** button, select **USB**, then press **OK** button.
3. The connected USB device is detected automatically for all its playable files, which will be automatically sorted into 3 types: **Music** , **Movie** , and **Photo** .



4. Press the  **BACK** button to go up to the top layer in the screen. Press   button to select the file type. Press **OK** button to enter its play list.
5. Select the file you want. Press **OK** button to start playing.
6. Follow the on-screen instruction to control the play option.
7. Press the **PLAY** buttons (    ) to control

playing.

#### Caution:

- The manufacturer is not responsible if the USB device is not supported, nor is it responsible for damage to or loss of data in the device.
- Do not overload the USB port. If you connect a USB storage device that consumes more than 500mA power, make sure that it is connected to its own external power supply.

#### 4.3.3. Play files from wireless device

1. Connect the display to a wireless device (see page 14).
2. Press the SOURCE button on the remote and Select Network.
3. Select a file from the content browser, than press OK button to start playing.
4. Use the remote control to control the media files on the display.

## 4.4. Play options

### 4.4.1. Playing music files

1. Select **Music**  in the top bar.
2. Select one music track, then press **OK** button.

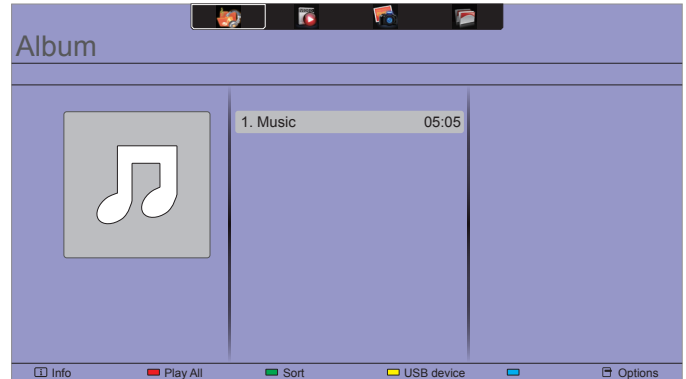



- To play all the tracks in a folder, select one music file, then select **{Play All}**.
- To pause the track, press **OK** button. Press **OK** button again to resume playback.
- To skip backward or forward 10 seconds, press **◀** or **▶** button.
- To search backward or forward, press **◀◀** or **▶▶** button, press repeatedly to toggle between different speeds.
- To stop the music, press **■** button.

#### Music options

While you play music, press  **OPTIONS** button, then press **OK** button to select an option:

- **{Repeat}**: Select **{Repeat}** to play a track or an album repeatedly, or select **{Play once}** to play a track once.
- **{Media Server}**: When you play content from a media server, you can select another media server.
- **{Shuffle On}** / **{Shuffle Off}**: Enable or disable random play of tracks.

**NOTE:** To view information about a song (for example, title, artist or duration), select the song, then press  **INFO** button. To hide the information, press  **INFO** button again.

### 4.4.2. Playing movie files

1. Select **Movie**  in the top bar.
2. Select a video, then press **OK** button.

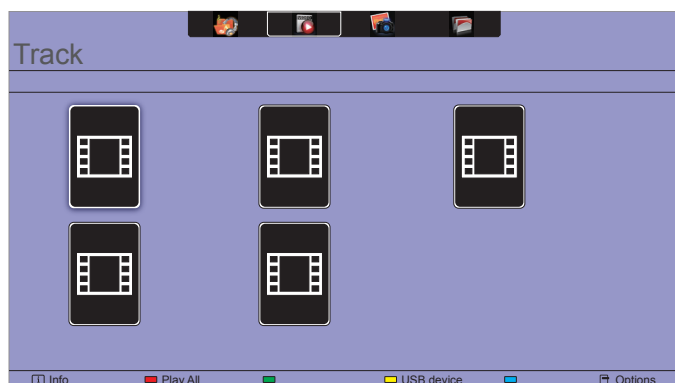



- To play all the videos in a folder, select one video file, then select **{Play All}**.
- To pause the video, press **OK** button. Press **OK** button again to resume playback.
- To skip backward or forward 10 seconds, press **◀** or **▶** button.
- To search backward or forward, press **◀◀** or **▶▶** button, press repeatedly to toggle between different speeds.
- To stop the video, press **■** button.

#### Movie options

While playing video, press  **OPTIONS** button, then press **OK** button to select an option:

- **{Subtitles}**: Select the available subtitle settings.
- **{Subtitle Language}**: Select the language for subtitles if available.
- **{Character Set}**: Select the correct character set for the subtitles.
- **{Audio Language}**: Select an audio language.
- **{Repeat}**: Select **{Repeat}** to play the video file repeatedly or **{Play once}** to play the video file once.
- **{Media server}**: When you play content from a media server, you can select another media server.
- **{Shuffle On}** / **{Shuffle Off}**: Enable or disable random play of video files.

**NOTE:** To view information about a video (for example, played position, duration, title, or date), select the video, then press  **INFO** button. To hide the information, press  **INFO** button again.

### 4.4.3. Playing photo files

1. Select **Photo**  in the top bar.
2. Select a photo thumbnail, then press **OK** button.

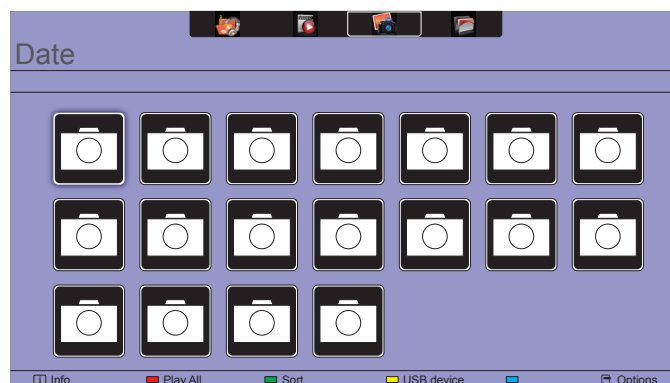

#### Start a slideshow

If there are multiple photos in a folder, select a photo, then select **{Play All}**.

- To skip to the previous or next photo, press **◀** or **▶** button, and then press **OK** button.
- To stop the slideshow, press **■** button.

#### Slideshow options

While you play a slideshow, press  **OPTIONS** button, then press **OK** button to select an option:

- **{Shuffle Off}** / **{Shuffle On}**: Enable or disable random display of pictures in the slideshow.
- **{Repeat}**: Select **{Repeat}** to watch a slideshow repeatedly or **{Play once}** to watch once.
- **{Slideshow Time}**: Select the displaying time for each photo in the slideshow.
- **{Slideshow Transitions}**: Select the transition from one photo to the next.
- **{Media Server}**: When you play content from a media server, you can select another media server.

## 5. Change your settings

Using the remote control:

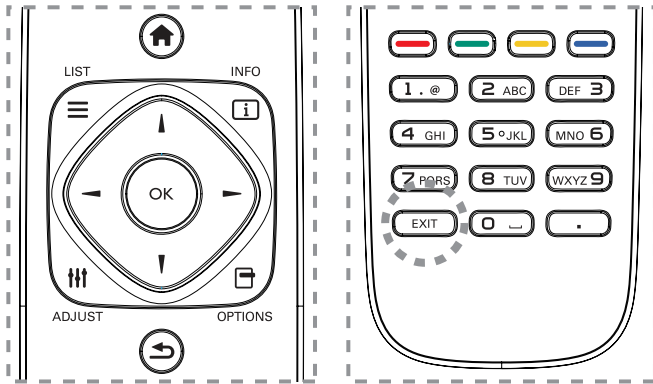

1. Press **HOME** button to display the OSD menu.
2. Press **▲**, **▼**, **←**, or **→** button to select its menu item or to adjust its value. Press **OK** button to confirm.
3. Press **BACK** button to go back to the previous menu layer.
4. Press **EXIT** button to exit the OSD menu.

Using this display's control buttons:

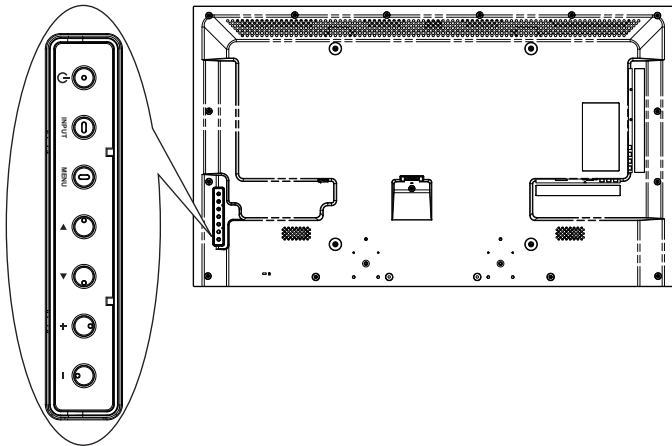

1. Press **MENU** button to display the OSD menu.
2. Press **▲** **▼** **+** or **-** button to select menu item or adjust its value.
3. Press **INPUT** button to confirm menu selection and enter its submenu.
4. Press **MENU** button to exit the OSD menu.

## 5.1. Settings

### 5.1.1. Picture menu

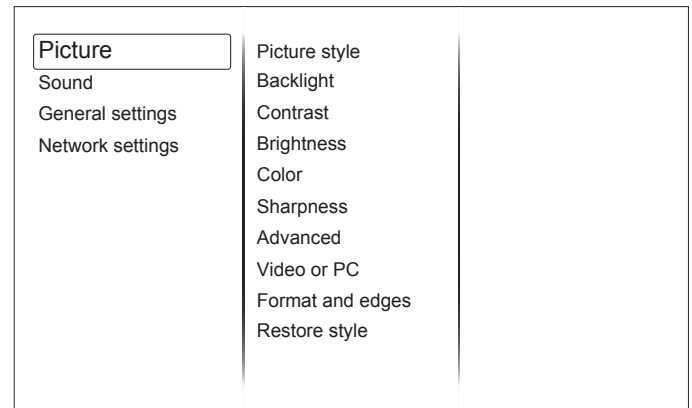

#### Picture style

Select a predefined picture setting.

#### Backlight

Adjust the brightness of this display's backlight.

#### Contrast

Adjust video contrast.

#### Brightness

Adjust screen brightness.

#### Color

Adjust the color saturation of the picture.

#### Sharpness

Adjust the sharpness of the picture.

#### Advanced

Access advanced settings such as gamma, tint settings and video contrast settings.

- **{Noise reduction}**: Select the amount of noise reduction for the picture.
- **{Gamma}**: Adjust the non-linear setting for picture luminance and contrast.
- **{Color temp.}**: Change the color balance.
- **{Custom color temp.}**: Customize color balance setting.
- **{Advanced sharpness}**: Enable superior sharpness, especially on lines and contours in the picture.
- **{Dynamic contrast}**: Adjusts contrast depending on content.
- **{Dynamic backlight}**: Adjusts backlight depending on content.
- **{Color enhancement}**: Color saturation changes depending on content.

#### Video or PC

When viewing content from a video source, select {Video} to apply video setting. When a computer is connected through HDMI, select {PC}.

Make sure that **{Format and edges}** → **{Picture format}** → **{Unscaled}** is selected so as to view maximum detail.



## Format and edges

Access advanced settings to control the displaying format of the picture.

- **{Picture format}**: Change the picture format.
- **{Screen edges}**: Change the picture size.
- **{Picture shift}**: If available, move the position of the picture.

## Restore style

Restore the last-selected predefined picture setting.

## 5.1.2. Sound menu

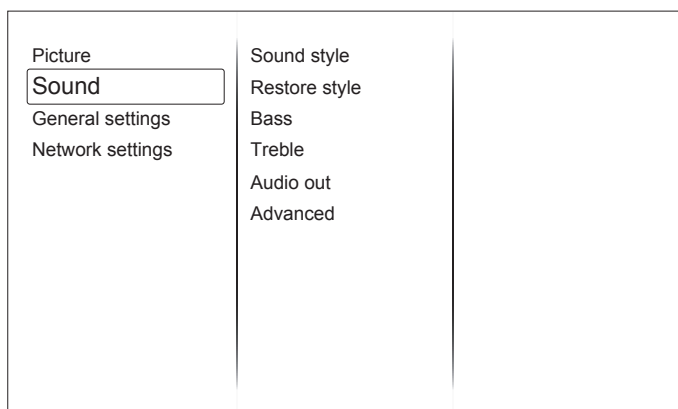

### Sound style

Access predefined sound settings.

### Restore style

Restore the last-selected predefined sound setting.

### Bass

Adjust the bass level of the speaker and headphones.

### Treble

Adjust the treble level of the speaker and headphones.

### Audio out

Adjust audio output volume.

### Advanced

Access advanced settings to enhance your audio experience.

- **{Auto volume leveling}**: Enable the reduction of sudden volume changes.
- **{Speaker}**: Turn on or off the internal speakers.
- **{Clear sound}**: Enhance sound quality.
- **{Audio out format}**: Select the type of audio output through the digital audio output connector.
- **{Audio out delay}**: Automatically sync the image on this display to the audio from a connected home theatre.
- **{Audio out offset}**: Adjust the setting for audio output delay. Available if **{Audio out delay}** is switched on.

## 5.1.3. General settings menu

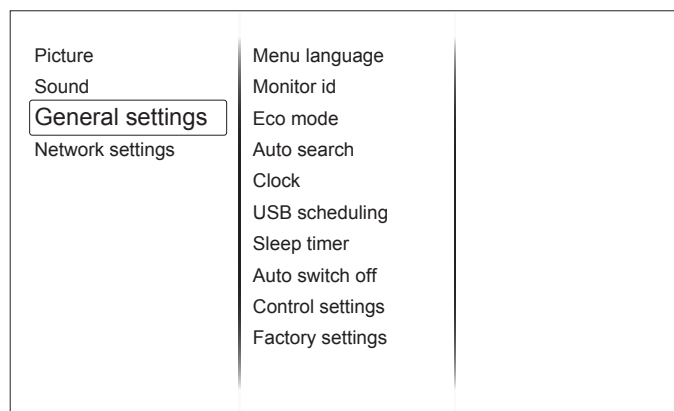

### Menu language

Select language used for OSD menus.

### Monitor id

Set the ID number for controlling this display via the RS232C connection. Each display must have a unique ID number when multiple sets of this display are connected.

### Eco mode

Select low power standby for lowest power consumption setting. Note: LAN control is not available under low power standby. Must use normal if using LAN control while display is in standby.

### Auto search

Choose to let this display detect and display available signal sources automatically.

### Clock

Adjust clock settings.

### USB scheduling

This function allows you to program up to 3 different scheduled time intervals for this display to activate, and auto play USB media file of your setting.

*After changing the **{Clock}** option in the **{General settings}** menu, you need to set this **{USB scheduling}** again.*

### Sleep timer

Switch off this display after a specified time.

### Auto switch off

Set the time for this display to be switched off after a period of no activity. Press any key on the remote control to disable this function.

### Control settings

- **{Local KB lock}**: Choose to enable or disable the keyboard (control buttons) function of this display.
  - **{Unlock}**: Enable the keyboard function.
  - **{Lock all}**: Lock all keyboard function.
  - **{Lock but volume}**: Disable all the keyboard function except the **VOL+** and **VOL-** button.
  - **{Lock but power}**: Disable all the keyboard function except the **POWER** button.
- **{RC lock}**: Choose to enable or disable the button function of the remote control.
  - **{Unlock}**: Enable the button function.

- **{Lock all}**: Lock all button function.
- **{Lock but volume}**: Disable all the button function except the **— + VOLUME** button.
- **{Lock but power}**: Disable all the button function except the **POWER** button.

**NOTE:** To disable the lock function from **[Local KB lock]** or **[RC lock]** item, press buttons **🏠 1 9 9 8** on the remote control.

### Factory settings

Reset all your customized settings to the factory defaults.

## 5.2. Network Settings

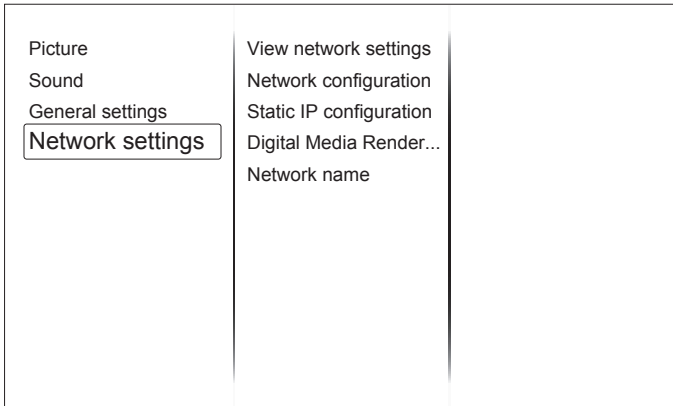

### View network settings

View connected network status.

### Network settings

Select how this display should assign addresses to the network resources.

### Static IP Configuration

Assign **{IP address}**, **{Netmask}**, **{Gateway}**, **{DNS1}**, and **{DNS2}** for this display.

### Digital Media Renderer - DMR

Receive multimedia files from Smart Phones or Tablets connected to your network.

See page 15 and 16 for setup and playback instructions.

### Network name

Rename this display for easy identification if you have more than one display connected to your network.

## 6. Input mode

### PC Resolution:

Standard Resolution	Active Resolution		Refresh Rate	Pixel Rate	Aspect Ratio	Stand for Mode
	H Pixels	V Lines				
VGA	640	480	60 Hz	25.175 MHz	4:3	Video Graphic Array
		480	72 Hz	31.5 MHz		
		480	75 Hz	31.5 MHz		
WVGA	720	400	70 Hz	33.75 MHz	16:9	Wide Video Graphic Array
SVGA	800	600	60 Hz	40 MHz	4:3	Super VGA
		600	75 Hz	49.5 MHz		
XGA	1024	768	60 Hz	65 MHz	4:3	Extended Graphic Array
		768	75 Hz	78.75 MHz		
WXGA	1280	768	60 Hz	79.5 MHz	5:3	Wide XGA
WXGA	1280	800	60 Hz	79.5 MHz	16:10	Wide XGA
SXGA	1280	1024	60 Hz	108 MHz	5:4	Super XGA
WXGA	1360	768	60 Hz	85.5 MHz	16:9	Wide XGA
UXGA	1600	1200	60 Hz	162 MHz	4:3	Ultra XGA
HD1080	1920	1080	60 Hz	148.5 MHz	16:9	HD1080

### SDTV Resolution:

Standard Resolution	Active Resolution		Refresh Rate	Pixel Rate	Aspect Ratio	Stand for Mode
	H Pixels	V Lines				
480i	720	480	29.97 Hz	13.5 MHz	4:3	Modified NTSC Standard
480p			59.94 Hz	27 MHz		
576i	720	480	25 Hz	13.5 MHz	4:3	Modified PAL Standard
576p			50 Hz	27 MHz		

### HDTV Resolution:

Standard Resolution	Active Resolution		Refresh Rate	Pixel Rate	Aspect Ratio	Stand for Mode
	H Pixels	V Lines				
720p	1280	720	50 Hz	74.25 MHz	16:9	Normally DVB Mode
			60 Hz			
1080i	1920	1080	25 Hz	74.25 MHz	16:9	Normally ATSC Mode
			30 Hz			
1080p	1920	1080	50 Hz	148.5 MHz	16:9	Normally ATSC Mode
			60 Hz			

- The PC text quality is optimum in HD 1080 mode (1920 × 1080, 60 Hz).
- Your PC display screen might appear different depending on the manufacturer (and your particular version of Windows).
- Check your PC instruction book for information about connecting your PC to a display.
- If a vertical and horizontal frequency-select mode exists, select 60 Hz (vertical) and 31.5 KHz (horizontal). In some cases, abnormal signals (such as stripes) might appear on the screen when the PC power is turned off (or if the PC is disconnected). If so, press the **[INPUT]** button to enter the video mode. Also, make sure that the PC is connected.
- When horizontal synchronous signals seem irregular in RGB mode, check PC power saving mode or cable connections.
- This display settings table complies to the IBM/VESA standards, and based on the analog input.
- The DVI support mode is regarded as same to the PC support mode.
- The best timing for the vertical frequency to each mode is 60 Hz.

## 7. Cleaning and Troubleshooting

### 7.1. Cleaning

#### Caution When Using the Display

- Do not bring your hands, face or objects close to the ventilation holes of the display. The top of the display is usually very hot due to the high temperature of exhaust air being released through the ventilation holes. Burns or personal injuries may occur if any body parts are brought too close. Placing any object near the top of the display could also result in heat related damage to the object as well as the display itself.
- Be sure to disconnect all cables before moving the display. Moving the display with its cables attached may damage the cables and thus cause fire or electric shock.
- Disconnect the power plug from the wall outlet as a safety precaution before carrying out any type of cleaning or maintenance procedure.

#### Front Panel Cleaning Instructions

- The front of the display has been specially treated. Wipe the surface gently using only a cleaning cloth or a soft, lint-free cloth.
- If the surface becomes dirty, soak a soft, lint-free cloth in a mild detergent solution. Wring the cloth to remove excess liquid. Wipe the surface of the display to remove dirt. Then use a dry cloth of the same type to dry.
- Do not scratch or hit the surface of the panel with fingers or hard objects of any kind.
- Do not use volatile substances such as insert sprays, solvents and thinners.

#### Cabinet Cleaning Instructions

- If the cabinet becomes dirty, wipe the cabinet with a soft, dry cloth.
- If the cabinet is extremely dirty, soak a lint-free cloth in a mild detergent solution. Wring the cloth to remove as much moisture as possible. Wipe the cabinet. Use another dry cloth to wipe over until the surface is dry.
- Do not allow any water or detergent to come into contact with the surface of the display. If water or moisture gets inside the unit, operating problems, electrical and shock hazards may result.
- Do not scratch or hit the cabinet with fingers or hard objects of any kind.
- Do not use volatile substances such as insert sprays, solvents and thinners on the cabinet.
- Do not place anything made from rubber or PVC near the cabinet for any extended periods of time.

## 7.2. Troubleshooting

Symptom	Possible Cause	Remedy
<b>No picture is displayed</b>	<ol style="list-style-type: none"> <li>1. The power cord is disconnected.</li> <li>2. The main power switch on the back of the display is not switched on.</li> <li>3. The selected input has no connection.</li> <li>4. The display is in standby mode.</li> </ol>	<ol style="list-style-type: none"> <li>1. Plug in the power cord.</li> <li>2. Make sure the power switch is switched on.</li> <li>3. Connect a signal connection to the display.</li> </ol>
<b>Interference displayed on the display or audible noise is heard</b>	Caused by surrounding electrical appliances or fluorescent lights.	Move the display to another location to see if the interference is reduced.
<b>Color is abnormal</b>	The signal cable is not connected properly.	Make sure that the signal cable is attached firmly to the back of the display.
<b>Picture is distorted with abnormal patterns</b>	<ol style="list-style-type: none"> <li>1. The signal cable is not connected properly.</li> <li>2. The input signal is beyond the capabilities of the display.</li> </ol>	<ol style="list-style-type: none"> <li>1. Make sure that the signal cable is attached firmly.</li> <li>2. Check the video signal source to see if it is beyond the range of the display. Please verify its specifications with this display's specification section.</li> </ol>
<b>Display image doesn't fill up the full size of the screen</b>	The zoom mode is not correctly set.	Use the Zoom mode or Custom zoom function in the Screen menu to fine tune display geometry and time frequency parameter.
<b>Can hear sound, but no picture</b>	Improperly connected source signal cable.	Make sure that both video inputs and sound inputs are correctly connected.
<b>Can see picture but no sound is heard</b>	<ol style="list-style-type: none"> <li>1. Improperly connected source signal cable.</li> <li>2. Volume is turned all the way down.</li> <li>3. <b>[MUTE]</b> is turned on.</li> <li>4. No external speaker connected.</li> </ol>	<ol style="list-style-type: none"> <li>1. Make sure that both video inputs and sound inputs are correctly connected.</li> <li>2. Press <b>[-]</b> or <b>[+]</b> button to hear sound.</li> <li>3. Switch MUTE off by using the  <b>[MUTE]</b> button.</li> <li>4. Connect external speakers and adjust the volume to a suitable level.</li> </ol>
<b>Some picture elements do not light up</b>	Some pixels of the display may not turn on.	This display is manufactured using an extremely high level of precision technology; however, sometimes some pixels of the display may not display. This is not a malfunction.
<b>After-Images can still be seen on the display after the display is powered off. (Examples of still pictures include logos, video games, computer images, and images displayed in 4:3 normal mode)</b>	A still picture is displayed for an over extended period of time	Do not allow a still image to be displayed for an extended period of time as this can cause a permanent after-image to remain on the display.

## 8. Technical Specifications

### 8.1. SL3250

#### Display:

Item	Specifications
Screen Size (Active Area)	31.5" LCD (80 cm)
Aspect Ratio	16:9
Number of Pixels	1920 (H) × 1080 (V)
Pixel Pitch	0.36375 (H) × 0.36375 (V) [mm]
Displayable Colors	16.7 Million colors
Brightness	350 cd/m <sup>2</sup>
Contrast Ratio (Typical)	3000:1
Viewing Angle	178 degrees

#### In/Out Terminals:

Item	Specifications
Speaker Output	Internal Speakers 5W (L) + 5W (R) [RMS]/16Ω, 1 Way 1 Speaker System 82 dB/W/M/160 Hz ~ 13 KHz
Audio Output	RCA Jack × 2 0.5V [rms] (Normal) / 2 Channel (L+R)
Audio Input	3.5 mm Stereo × 1 RCA Jack × 2 0.5V [rms] (Normal) / 2 Channel (L+R)
RS232C Input/Output	2.5 mm × 2 TXD + RXD (1:1)
LAN	RJ-45 Jack × 1 (8 pin) 10/100 LAN Port
HDMI Input	HDMI Jack × 1 (Type A) (19 pin) Digital RGB: TMDS (Video + Audio) MAX: Video: 720p, 1080p, 1920 × 1080/60 Hz (WUXGA) Audio: 48 KHz / 2 Channel (L+R) Supports LPCM only
DVI-D Input	DVI-D jack Digital RGB: TMDS (Video)
VGA Input	D-Sub Jack × 1 (15 pin) Analog RGB: 0.7V [p-p] (75Ω), H/CS/V: TTL (2.2kΩ), SOG: 1V [p-p] (75Ω) MAX: 720p, 1080p, 1920 × 1080/60 Hz (WUXGA)
Component Input	RCA Jack × 3 Y: 1V [p-p] (75Ω), Pb: 0.7V [p-p] (75Ω), Pr: 0.7V [p-p] (75Ω) MAX: 480i, 576i, 480p, 576p, 720p, 1080i, 1080p
SPDIF Output	SPDIF Port Serial digital audio output when input is HDMI
IR Input/Output	3.5 mm × 2 IR pass through or IR daisy chain
USB Input	USB × 1 (Type B) USB 2.0, External PC connection

#### General:

Item	Specifications
Power Input	100-240V~ 50-60Hz, 1.5A
Power Consumption (Max.)	68 W
Power Consumption (Typical)	55 W
Power Consumption (EPA6.0)	40 W
Power Consumption (Standby & Off)	< 0.5W (OSD: APM mode off)
Dimensions [W × H × D]	745 × 439.5 × 39.8 mm
Weight	6.6 Kg
Gross Weight	9.0 Kg

#### Environmental Condition:

Item	Specifications	
Temperature	Operational	5 ~ 40°C
	Storage	-20 ~ 60°C
Humidity	Operational	20 ~ 80% RH (No condensation)
	Storage	10 ~ 90% RH (No condensation)
Altitude	Operational	0 ~ 2,000 m
	Storage	0 ~ 5,000 m

## 8.2. SL4250

**Display:**

Item	Specifications
Screen Size (Active Area)	42" LCD (106.7 cm)
Aspect Ratio	16:9
Number of Pixels	1920 (H) × 1080 (V)
Pixel Pitch	0.4845 (H) × 0.4845 (V) [mm]
Displayable Colors	16.7 Million colors
Brightness	350 cd/m <sup>2</sup>
Contrast Ratio (Typical)	3000:1
Viewing Angle	178 degrees

**In/Out Terminals:**

Item	Specifications
Speaker Output	Internal Speakers 7W (L) + 7W (R) [RMS]/16Ω, 1 Way 1 Speaker System 82 dB/W/M/160 Hz ~ 13 KHz
Audio Output	RCA Jack × 2 0.5V [rms] (Normal) / 2 Channel (L+R)
Audio Input	3.5 mm Stereo × 1 RCA Jack × 2 0.5V [rms] (Normal) / 2 Channel (L+R)
RS232C Input/Output	2.5 mm × 2 TXD + RXD (1:1)
LAN	RJ-45 Jack × 1 (8 pin) 10/100 LAN Port
HDMI Input	HDMI Jack × 1 (Type A) (19 pin) Digital RGB: TMDS (Video + Audio) MAX: Video: 720p, 1080p, 1920 × 1080/60 Hz (WUXGA) Audio: 48 KHz / 2 Channel (L+R) Supports LPCM only
DVI-D Input	DVI-D jack Digital RGB: TMDS (Video)
VGA Input	D-Sub Jack × 1 (15 pin) Analog RGB: 0.7V [p-p] (75Ω), H/CS/V: TTL (2.2kΩ), SOG: 1V [p-p] (75Ω) MAX: 720p, 1080p, 1920 × 1080/60 Hz (WUXGA)
Component Input	RCA Jack × 3 Y: 1V [p-p] (75Ω), Pb: 0.7V [p-p] (75Ω), Pr: 0.7V [p-p] (75Ω) MAX: 480i, 576i, 480p, 576p, 720p, 1080i, 1080p
SPDIF Output	SPDIF Port Serial digital audio output when input is HDMI
IR Input/Output	3.5 mm × 2 IR pass through or IR daisy chain
USB Input	USB × 1 (Type B) USB 2.0, External PC connection

**General:**

Item	Specifications
Power Input	100-240V ~ 50-60Hz, 2.5A
Power Consumption (Max.)	104 W
Power Consumption (Typical)	88 W
Power Consumption (EPA6.0)	61 W
Power Consumption (Standby & Off)	< 0.5W (OSD: APM mode off)
Dimensions [W × H × D]	980.4 × 572.9 × 38.5 mm
Weight	11.9 Kg
Gross Weight	15.3 Kg

**Environmental Condition:**

Item	Specifications	
Temperature	Operational	5 ~ 40°C
	Storage	-20 ~ 60°C
Humidity	Operational	20 ~ 80% RH (No condensation)
	Storage	10 ~ 90% RH (No condensation)
Altitude	Operational	0 ~ 2,000 m
	Storage	0 ~ 5,000 m

**8.3. SL4650****Display:**

Item	Specifications
Screen Size (Active Area)	46" LCD (116.8 cm)
Aspect Ratio	16:9
Number of Pixels	1920 (H) × 1080 (V)
Pixel Pitch	0.53025 (H) × 0.53025 (V) [mm]
Displayable Colors	16.7 Million colors
Brightness	350 cd/m <sup>2</sup>
Contrast Ratio (Typical)	4000:1
Viewing Angle	178 degrees

**In/Out Terminals:**

Item	Specifications
Speaker Output	Internal Speakers 7W (L) + 7W (R) [RMS]/16Ω, 1 Way 1 Speaker System 82 dB/W/M/160 Hz ~ 13 KHz
Audio Output	RCA Jack × 2 0.5V [rms] (Normal) / 2 Channel (L+R)
Audio Input	3.5 mm Stereo × 1 RCA Jack × 2 0.5V [rms] (Normal) / 2 Channel (L+R)
RS232C Input/Output	2.5 mm × 2 TXD + RXD (1:1)
LAN	RJ-45 Jack × 1 (8 pin) 10/100 LAN Port
HDMI Input	HDMI Jack × 1 (Type A) (19 pin) Digital RGB: TMDS (Video + Audio) MAX: Video: 720p, 1080p, 1920 × 1080/60 Hz (WUXGA) Audio: 48 KHz / 2 Channel (L+R) Supports LPCM only
DVI-D Input	DVI-D jack Digital RGB: TMDS (Video)
VGA Input	D-Sub Jack × 1 (15 pin) Analog RGB: 0.7V [p-p] (75Ω), H/CS/V: TTL (2.2kΩ), SOG: 1V [p-p] (75Ω) MAX: 720p, 1080p, 1920 × 1080/60 Hz (WUXGA)
Component Input	RCA Jack × 3 Y: 1V [p-p] (75Ω), Pb: 0.7V [p-p] (75Ω), Pr: 0.7V [p-p] (75Ω) MAX: 480i, 576i, 480p, 576p, 720p, 1080i, 1080p
SPDIF Output	SPDIF Port Serial digital audio output when input is HDMI
IR Input/Output	3.5 mm × 2 IR pass through or IR daisy chain
USB Input	USB × 1 (Type B) USB 2.0, External PC connection

**General:**

Item	Specifications
Power Input	100-240V ~ 50-60Hz, 2.5A
Power Consumption (Max.)	104 W
Power Consumption (Typical)	88 W
Power Consumption (EPA6.0)	66 W
Power Consumption (Standby & Off)	< 0.5W (OSD: APM mode off)
Dimensions [W × H × D]	1068 × 622.5 × 38.8 mm
Weight	13.7 Kg
Gross Weight	17.2 Kg

**Environmental Condition:**

Item	Specifications	
Temperature	Operational	5 ~ 40°C
	Storage	-20 ~ 60°C
Humidity	Operational	20 ~ 80% RH (No condensation)
	Storage	10 ~ 90% RH (No condensation)
Altitude	Operational	0 ~ 2,000 m
	Storage	0 ~ 5,000 m



## 8.4. SL5550

**Display:**

Item	Specifications
Screen Size (Active Area)	54.6" LCD (138.7 cm)
Aspect Ratio	16:9
Number of Pixels	1920 (H) × 1080 (V)
Pixel Pitch	0.630 (H) × 0.630 (V) [mm]
Displayable Colors	16.7 Million colors
Brightness	350 cd/m <sup>2</sup>
Contrast Ratio (Typical)	1400:1
Viewing Angle	178 degrees

**In/Out Terminals:**

Item	Specifications
Speaker Output	Internal Speakers 7W (L) + 7W (R) [RMS]/16Ω, 1 Way 1 Speaker System 82 dB/W/M/160 Hz ~ 13 KHz
Audio Output	RCA Jack × 2 0.5V [rms] (Normal) / 2 Channel (L+R)
Audio Input	3.5 mm Stereo × 1 RCA Jack × 2 0.5V [rms] (Normal) / 2 Channel (L+R)
RS232C Input/Output	2.5 mm × 2 TXD + RXD (1:1)
LAN	RJ-45 Jack × 1 (8 pin) 10/100 LAN Port
HDMI Input	HDMI Jack × 1 (Type A) (19 pin) Digital RGB: TMDS (Video + Audio) MAX: Video: 720p, 1080p, 1920 × 1080/60 Hz (WUXGA) Audio: 48 KHz / 2 Channel (L+R) Supports LPCM only
DVI-D Input	DVI-D jack Digital RGB: TMDS (Video)
VGA Input	D-Sub Jack × 1 (15 pin) Analog RGB: 0.7V [p-p] (75Ω), H/CS/V: TTL (2.2kΩ), SOG: 1V [p-p] (75Ω) MAX: 720p, 1080p, 1920 × 1080/60 Hz (WUXGA)
Component Input	RCA Jack × 3 Y: 1V [p-p] (75Ω), Pb: 0.7V [p-p] (75Ω), Pr: 0.7V [p-p] (75Ω) MAX: 480i, 576i, 480p, 576p, 720p, 1080i, 1080p
SPDIF Output	SPDIF Port Serial digital audio output when input is HDMI
IR Input/Output	3.5 mm × 2 IR pass through or IR daisy chain
USB Input	USB × 1 (Type B) USB 2.0, External PC connection

**General:**

Item	Specifications
Power Input	100-240V ~ 50-60Hz, 2.5A
Power Consumption (Max.)	128 W
Power Consumption (Typical)	109 W
Power Consumption (EPA6.0)	73 W
Power Consumption (Standby & Off)	< 0.5W (OSD: APM mode off)
Dimensions [W × H × D]	1264.7 × 735.5 × 42.8 mm
Weight	21.2 Kg
Gross Weight	25.7 Kg

**Environmental Condition:**

Item	Specifications	
Temperature	Operational	5 ~ 40°C
	Storage	-20 ~ 60°C
Humidity	Operational	20 ~ 80% RH (No condensation)
	Storage	10 ~ 90% RH (No condensation)
Altitude	Operational	0 ~ 2,000 m
	Storage	0 ~ 5,000 m

## **PLANAR SUPPORT**

### **Technical Support**

Visit Planar at <http://www.planar.com/support> for user manuals and warranty information.

To speak with Planar Customer Support please have you model and serial number available and dial:

### **Planar Support**

Tel: 1-866-PLANAR1 (866-752-6271) or +1 503-748-5799 outside the US.

Hours: 24 hours a day, 7 days a week.

**Toll or long distance charges may apply.**

## **Planar Systems, Inc.**

Customer Service  
24x7 Online Technical Support: <http://www.planar.com/support>  
1195 NW Compton Drive  
Beaverton, OR 97006-1992  
Tel: 1-866-PLANAR1 (866-752-6271), or +1 503-748-5799 outside the United States,  
Hours: 24 hours a day, 7 days a week

©2013 Planar Systems, Inc.  
Planar is a registered trademark of Planar Systems, Inc. Other brands and names are the property of their respective owners. Technical information in this document is subject to change without notice.



PN: 020-1242-00