



PX2411W LCD Monitor

USER'S GUIDE

www.planar.com

Planar utilizes HDMI® standards in this product.

The terms HDMI, HDMI High-Definition Multimedia Interface, HDMI Trade dress and the HDMI Logos are trademarks or registered trademarks of HDMI Licensing Administrator, Inc.

Planar Systems, Inc

1195 NW Compton Drive
Beaverton, OR 97006-1992
www.planar.com

Customer Service

Planar provides the following technical support services:

Internet Support

For support available 24/7 visit Planar's Online Technical Support at www.planar.com/support. Our Online Technical Support is where you'll find solutions to many common problems, download documentation, view answers to frequently asked questions (FAQs) and get troubleshooting advice, or email Planar your support question.

Talk to a Customer Service Representative

To contact Planar's Customer First(TM) Technical Support Service call 1.866.PLANAR.1 (866.752.6271). This service is available 5am - 5pm Pacific Time, 8am - 8pm Eastern Time, Monday through Friday.

Contact Us

24x7 Online Technical Support: <http://www.planar.com/support>

Email: PlanarSupport@planar.com

Tel: 1-866-PLANAR1 (866) 752-6271

Hours: M-F, 5am - 5pm Pacific Time, 8am - 8pm Eastern

The information contained in this document is subject to change without notice. This document contains proprietary information that is protected by copyright. All rights are reserved. No part of this document may be reproduced, translated to another language or stored in a retrieval system, or transmitted by any means, electronic, mechanical, photocopying, recording, or otherwise, without prior written permission. Windows is a registered trademark of Microsoft Inc. Other brand or product names are trademarks of their respective holders.

TABLE OF CONTENTS

For Your Safety

<i>For Your Safety</i> -----	5
------------------------------	---

General Notes

<i>Special notes on LCD monitors</i> -----	7
<i>Other notes</i> -----	7

Before You Operate The Monitor

<i>Features</i> -----	8
<i>Checking the contents of the package</i> -----	8

Installation Instructions

<i>Power source</i> -----	9
<i>Connecting the cables</i> -----	10
<i>Tilt and height adjustment</i> -----	11

Operating Instructions

<i>External controls</i> -----	12
<i>How to adjust a setting</i> -----	14
<i>The descriptions for function control LEDs</i> -----	15

Technical Support (FAQ)

<i>Technical Support (FAQ)</i> -----	17
<i>Error message & possible solution</i> -----	18

Appendix

<i>Specifications</i> -----	19
<i>Preset display modes</i> -----	21
<i>Connector pin assignment</i> -----	22

FOR YOUR SAFETY

Before operating the monitor, please read this manual thoroughly. This manual should be retained for future reference.

FCC Class B Radio Frequency Interference Statement

WARNING: (FOR FCC CERTIFIED MODELS)

NOTE: This equipment has been tested and found to comply with the limits for a Class B digital device, pursuant to Part 15 of the FCC Rules. These limits are designed to provide reasonable protection against harmful interference in a residential installation. This equipment generates, uses and can radiate radio frequency energy, and if not installed and used in accordance with the instructions, may cause harmful interference to radio communications. However, there is no guarantee that interference will not occur in a particular installation. If this equipment does cause harmful interference to radio or television reception, which can be determined by turning the equipment off and on, the user is encouraged to try to correct the interference by one or more of the following measures:

1. Reorient or relocate the receiving antenna.
2. Increase the separation between the equipment and receiver.
3. Connect the equipment into an outlet on a circuit different from that to which the receiver is connected.
4. Consult the dealer or an experienced radio/TV technician for help.

 LAMP(S) INSIDE THIS PRODUCT CONTAIN MERCURY AND MUST BE RECYCLED OR DISPOSED OF ACCORDING TO LOCAL, STATE OR FEDERAL LAWS. FOR MORE INFORMATION, CONTACT THE ELECTRONIC INDUSTRIES ALLIANCE AT WWW.EIAE.ORG. FOR LAMP SPECIFIC DISPOSAL INFORMATION CHECK WWW.LAMPRECYCLE.ORG.

NOTICE:

1. The changes or modifications not expressly approved by the party responsible for compliance could void the user's authority to operate the equipment.
2. Shielded interface cables and AC power cord, if any, must be used in order to comply with the emission limits.
3. The manufacturer is not responsible for any radio or TV interference caused by unauthorized modification to this equipment. It is the responsibilities of the user to correct such interference.

WARNING:

To prevent fire or shock hazard, do not expose the monitor to rain or moisture. Dangerously high voltages are present inside the monitor. Do not open the cabinet. Refer servicing to qualified personnel only.

PRECAUTIONS

- Do not use the monitor near water, e.g. near a bathtub, washbowl, kitchen sink, laundry tub, swimming pool or in a wet basement.
- Do not place the monitor on an unstable cart, stand, or table. If the monitor falls, it can injure a person and cause serious damage to the appliance. Use only a cart or stand recommended by the manufacturer or sold with the monitor. If you mount the monitor on a wall or shelf, use a mounting kit approved by the manufacturer and follow the kit instructions.
- Slots and openings in the back and bottom of the cabinet are provided for ventilation. To ensure reliable operation of the monitor and to protect it from overheating, be sure these openings are not blocked or covered. Do not place the monitor on a bed, sofa, rug, or similar surface. Do not place the monitor near or over a radiator or heat register. Do not place the monitor in a bookcase or cabinet unless proper ventilation is provided.
- Do not install the monitor in a location near heat sources such as radiators or air ducts, or in a place subject to direct sunlight, or excessive dust or mechanical vibration or shock.
- The monitor should be operated only from the type of power source indicated on the label. If you are not sure of the type of power supplied to your home, consult your dealer or local power company.
- The monitor is equipped with a three-pronged grounded plug, a plug with a third (grounding) pin. This plug will fit only into a grounded power outlet as a safety feature. If your outlet does not accommodate the three-wire plug, have an electrician install the correct outlet or ground the appliance safely. Do not defeat the safety purpose of the grounded plug.
- Unplug the unit during a lightning storm or when it will not be used for long period of time. This will protect the monitor from damage due to power surges.
- Do not overload power strips and extension cords. Overloading can result in fire or electric shock.
- Never push any object into the slot on the monitor cabinet. It could short circuit parts causing a fire or electric shock. Never spill liquids on the monitor.
- Do not attempt to service the monitor by yourself. Opening or removing covers can expose you to dangerous voltages and other hazards. Please refer all servicing to qualified service personnel.
- To ensure satisfactory operation, use the monitor only with UL listed computers which have appropriate configured receptacles marked between 100 - 240V AC, Min. 5A.
- The wall socket shall be installed near the equipment and shall be easily accessible.

GENERAL NOTES

SPECIAL NOTES ON LCD MONITORS

The following symptoms are normal with LCD monitor and do not indicate a problem.

- Due to the nature of the fluorescent light, the screen may flicker during initial use. Turn off the Power Switch and then turn it on again to make sure the flicker disappears.
- You may find slightly uneven brightness on the screen depending on the desktop pattern you use.
- The LCD panel used in this monitor is a very high technology product with 6,912,000 thin film transistors giving you fine picture details. Occasionally, a few non-active pixels may appear on the screen as a fixed point of red, green, blue, white or black. Please note that this does not indicate a defective panel.
- Due to the nature of the LCD screen, an after-image of the previous screen may remain after switching the image when the same image has been displayed for a long time. The monitor will slowly recover from this.
- LCD monitors have a fixed size & number of pixels. Due to this, an interpolation is necessary to operate the monitor in a relation below it's native resolution which may slightly degrade the display quality. Therefore, it is highly recommended to operate the monitor at it's native resolution of 1920 x 1200 @ 60Hz.

OTHER NOTES

- The screen surface is very soft. Do not rub, touch or tap the screen surface with sharp object such as pen or pencil. This contact may scratch or damage the screen. These damages are not covered under the warranty.
- Turn your computer OFF before installing your new monitor. Refer to your computer manual for the proper shut down procedure.
- Save the original shipping carton and packing materials, as they will come in handy if you ever have to ship your monitor.
- For maximum protection, repackage your monitor as it was originally packed at the factory.
- To keep the monitor looking new, periodically clean the case & surface of the TFT-LCD panel with a soft non-fibrous cloth lightly dampened with a glass cleaner. Do not use any paper products to clean the screen. Never spray the glass cleaner directly on the monitor. Never use strong solvents such as thinner, benzene, or abrasive cleaners, since these will damage the case & panel. As a safety precaution, always unplug the monitor before cleaning it.







BEFORE YOU OPERATE THE MONITOR

FEATURES

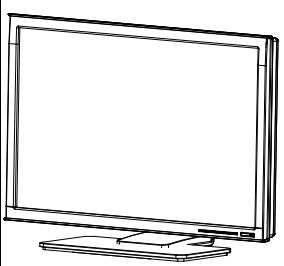
- 24" (61cm) TFT Color LCD Monitor
- Crisp & Clear Display for Windows
- Recommended Resolution: 1920 X 1200 @ 60Hz
- Ergonomic Design with Tilt Adjustable Stand
- Space Saving, Compact Case Design

CHECKING THE CONTENTS OF THE PACKAGE

The product package should include the following items:

		
Monitor	Base	User Manual
		
24-Pin DVI Cable	Power Cord	15-pin D-Sub Cable

Register Your Planar Products Today

Thank you for choosing Planar. To assure you receive all the benefits of your Planar product and services, register your Planar product today. Visit our website to register your product at http://www.planar.com/support/product_registration.html

Cables, Replacement Lamps and Accessories

To find cables, replacement lamps and accessories for your Planar projector, LCD monitor, touchscreen or other Planar products visit our online store at www.PlanarOnline.com or find other stores who carry Planar products at <http://www.planar.com/howtobuy>

INSTALLATION INSTRUCTIONS

Power Source:

1. Make sure that the power cord is the correct type required in your area.
2. This LCD monitor has an internal Universal Power Supply that allows operation in either 100/120V AC or 220/240V AC voltage area (No user adjustment is required.)
3. Connect the AC-power cord into your LCD monitor's AC-power-input. The AC-power cord may be connected to either a wall power outlet or the power outlet socket on your PC, depending on the type of power cord supplied with your LCD monitor.

A certified power supply cord has to be used with this equipment. The relevant national installation and/or equipment regulations shall be considered. A certified power supply cord not lighter than ordinary polyvinyl chloride flexible cord according to IEC 60227 (designation H05VV-F 3G 0.75mm² or H05VVH2-F2 3G 0.75mm²) shall be used. As an alternate, a flexible cord of synthetic rubber according to IEC 60245 (designation H05RR-F 3G 0.75mm²) shall be used.

The accessory power cord for the Northern American region is the wall plug with NEMA 5-15 style and is UL listed and CSA labeled. The voltage rating for the power cord shall be 125 volts AC.

Supplied with units intended for connection to power outlet of personal computer: Please use a cord set consisting of a minimum No. 18 AWG, type SJT or SVT three conductors flexible cord. One end terminates with a grounding type attachment plug, rated 10A, 250V, CEE-22 male configuration. The other end terminates with a molded-on type connector body, rated 10A, 250V, having standard CEE-22 female configuration.

Please note that power supply cord needs to use VDE 0602, 0625, 0821 approval power cord in European counties.

INSTALLATION INSTRUCTIONS (cont.)

Connecting The Cables

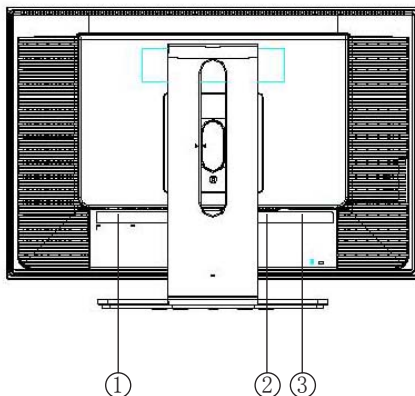

Figure 2 Connecting Cables

1.	AC Power Cord	2	DVI Cable
3.	15-pin D-SUB Cable		

Turn off your computer before performing the procedure below.

1. Connect the female end of the AC power cord to the AC-in port on the back of the monitor. Connect the other end to a nearby AC-outlet.
2. Connect one end of the 15-pin D-Sub cable to the back of the monitor and connect the other end to the computer's D-Sub port.
3. (Optional – Requires a video card with DVI port) Connect one end of the 24-pin DVI cable to the back of the monitor and connect the other end to the computer's DVI port. be tightened.
4. Turn on your monitor and computer. If you monitor displays an image, installation is complete. If not, refer to the FAQ (frequently asked questions) section for troubleshooting.

INSTALLATION INSTRUCTIONS (cont.)

Tilt Adjustment

For optimal viewing it is recommended to look at the full face of the monitor, then adjust the monitor's angle to your own preference.

Hold the stand so you do not topple the monitor when you change the monitor's angle.

You are able to adjust the monitor's angle from -5° to 20° .

You are able to adjust the monitor's height adjustable stand 3.55"(90.2mm).

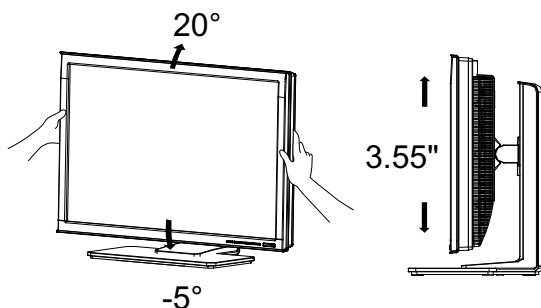

Figure 3

NOTES

- Do not touch the LCD screen when making the adjustments above. It may cause damage or break the LCD screen.
- Careful attention is required not to catch your fingers or hands when making the adjustments above.

OPERATING INSTRUCTIONS

EXTERNAL CONTROLS

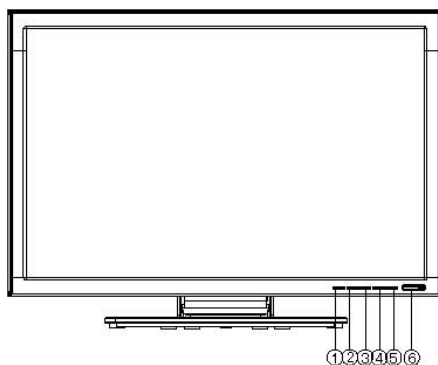

Figure 4 - External Controls

1.	Source	4.	>/Brightness
2.	Auto Adjust button/Exit	5.	Menu/Enter
3.	</Contrast	6.	Power Button

- **Power Button:**
Press this button to turn the monitor ON or OFF.
- **>/Brightness**
Adjust brightness or function adjust.
- **</Contrast**
Adjust contrast or function adjust.
- **MENU / ENTER:**
Activates OSD menu or confirms function.
- **Source**
Select the VGA or DVI function.

OPERATING INSTRUCTIONS (cont.)

- **Auto Adjust button / Exit:**

1. When OSD menu is in active status, this button will act as EXIT-KEY (EXIT OSD menu) or go back to the previous menu.
2. When OSD menu is in off status, press this button for 2 seconds to activate the Auto Adjustment function.
The Auto Adjustment function is used to set the HPos, VPos, Clock and Focus.

- **Power Indicator:**

Green — Power On mode.
Amber — Standby mode.

- **OSD-Lock Function:** To lock the OSD, press and hold the MENU-button while the monitor is off and then press power button to turn the monitor on. To un-lock the OSD - press and hold the MENU- button while the monitor is off and then press power button to turn the monitor on.

OPERATING INSTRUCTIONS (cont.)

How To Adjust A Setting

1. Press the MENU-button to activate the OSD window (Figure 5).
2. Press < or > to navigate through the functions. Once the desired function is highlighted, press the MENU-button to activate it. If the function selected has a sub-menu, press < or > again to navigate through the sub-menu functions. Once the desired function is highlighted, press MENU-button to activate it.
3. Press < or > to change the settings of the selected function.
4. To exit and save, select the exit function. If you want to adjust any other function, repeat steps 2-3.

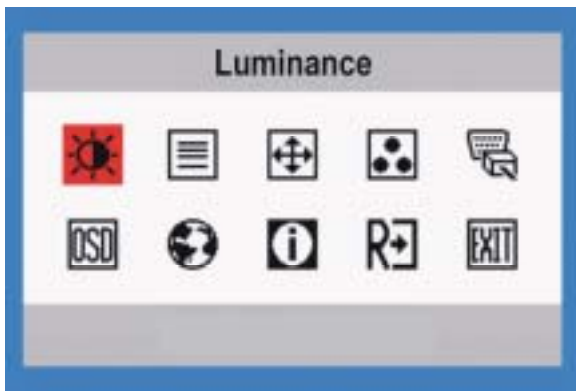





















Figure 5 The OSD Message

OPERATING INSTRUCTIONS (cont.)

The descriptions for function control LEDs

Main Menu Item	Main Menu Icon	Sub Menu Item	Sub Menu Icon	Description
Luminance		Contrast		Adjusts Contrast.
		Brightness		Adjusts Brightness.
Image Setup		Focus		Adjust Picture Phase to reduce Horizontal-Line noise
		Clock		Adjust picture Clock to reduce Vertical-Line noise.
Image Position		H. Position		Adjust the horizontal position of the picture.
		V. Position		Adjust the vertical position of the picture.
Color Temp.		Warm	N/A	Sets display to Warm Color temperature.
		Cool	N/A	Sets display to Cool Color temperature.
		sRGB	N/A	Sets to sRGB temperature.
		User / Red	R	User defines Red gain.
		User / Green	G	User defines Green gain.
		User / Blue	B	User defines Blue gain.

OPERATING INSTRUCTIONS (cont.)

Main Menu Item	Main Menu Icon	Sub Menu Item	Sub Menu Icon	Description
Input Select		Analog	N/A	Select input signal from analog source(D-Sub)
		Digital	N/A	Select input signal from digital source (DVI)
OSD Setup		H. Position		Adjust the horizontal position of the OSD.
		V. Position		Adjust the vertical position of the OSD.
		OSD Timeout		Adjust the OSD timeout.
Language		Language	N/A	Set OSD language
Information		Information	N/A	Show the resolution, H/V frequency and input port of current input timing.
Reset		Yes	N/A	Reset to factory default setting.
		No	N/A	Do not execute reset, return to main menu.
Exit		N/A	N/A	Exit OSD

TECHNICAL SUPPORT (FAQ)

Problem & Question	Possible Solution
Power LED is not on	<ul style="list-style-type: none"> *Check if the Power Switch is in the ON position *Power Cord should be connected
No Plug & Play	<ul style="list-style-type: none"> *Check if the PC system is Plug & Play compatible *Check if the Video Card is Plug & Play compatible *Check if the D-15 plug pin of Video Cable is bent *Make sure the LCD Monitor Drivers are installed
Picture is fuzzy	<ul style="list-style-type: none"> *Adjust the Contrast and Brightness Controls.
Picture bounces or a wave pattern is present in the picture	<ul style="list-style-type: none"> *Move electrical devices that may cause electrical interference.
The power LED is ON (Amber) but there's no video or no picture.	<ul style="list-style-type: none"> *Computer Power Switch should be in the ON position. *Computer Video Card should be snugly seated in its slot *Make sure monitor's video cable is properly connected to the computer. *Inspect monitor's video cable and make sure none of the pins are bent. *Make sure computer is operational by hitting the CAPS LOCK key on the keyboard while observing the CAPS LOCK LED. The LED should either turn ON or OFF after hitting the CAPS LOCK key.
Missing one of the primary colors (RED, GREEN, or BLUE)	<ul style="list-style-type: none"> *Inspect the monitor's video cable and make sure that none of the pins are bent.
Screen image is not centered or sized properly.	<ul style="list-style-type: none"> *Adjust pixel frequency (CLOCK) and FOCUS or press hot-key (AUTO)
Picture has color defects (white does not look white)	<ul style="list-style-type: none"> *Adjust RGB color or select color temperature
Horizontal or vertical disturbances on the screen	<ul style="list-style-type: none"> *Use win 95/98 shut-down mode Adjust CLOCK and FOCUS or perform hot-key (AUTO-key).

TECHNICAL SUPPORT (FAQ) (cont.)

CLOCK (pixel frequency) controls the number of pixels scanned by one horizontal sweep. If the frequency is not correct, the screen shows vertical stripes and the picture has not correct width.

FOCUS adjusts the phase of the pixel clock signal. With a wrong phase adjustment the picture has horizontal disturbances in light picture.

For FOCUS and CLOCK adjustment use “dot-pattern” or win 95/98 shut-down mode pattern.

ERROR MESSAGE & POSSIBLE SOLUTION

CABLE NOT CONNECTED :

1. Check that the signal-cable is properly connected , If the connector is loose, tighten the connector’s screws.
2. Check the signal -cable connection pins for damage.

INPUT NOT SUPPORTED :

Your computer has been set to unsuitable display mode. Set the computer to a display mode given in the Preset Display Modes table.

APPENDIX

SPECIFICATIONS

LCD Panel	Driving system	TFT Color LCD
	Size	61cm(24")
	Pixel pitch	0.270mm(H)x 0.270mm(V)
Input	Video	R,G,B Analog Interface
		Digital interface
	H-Frequency	30KHz – 94KHz
	V-Frequency	56-75Hz
Display Colors		16.7M Colors
Dot Clock		165 MHz
Max. Resolution		1920 x 1200 @ 60Hz
Plug & Play		VESA DDC2B™
Power Consumption	ON Mode	80 W
	OFF Mode	1.5W
Input Connector		D-Sub 15pin
		DVI 24pin
Input Video Signal		Analog:0.7Vp-p(standard), 75 OHM, Positive
		Digital signal
Maximum Screen Size		Horizontal : 518.4mm Vertical : 324.0mm
Power Source		100~240VAC,50~60HZ
Environmental Considerations		Operating Temp: 10° to 35°C Storage Temp.: -20° to 60°C Operating Humidity: 5% to 95%
Dimensions		567.2(W)X413.8(H)X173.3(D)mm
Weight (N. W.)		10.25kg Unit (net)

APPENDIX (cont.)

External Controls:	Switch	<ul style="list-style-type: none"> • Auto Adjust button/Exit • Contrast • Brightness • Menu/Enter • Power Button
	Functions	<ul style="list-style-type: none"> • Contrast • Brightness • Focus • Clock • H.Position • V.Position • (Warm) Color • (Cool)Color • sRGB Color temperature • User • Input signal Selection • OSD Setup • Language • Display information • Reset • Exit
Power Consumption	(Maximum)	80 Watts
Regulatory Compliance		UL/cUL,CE,FCC B

APPENDIX (cont.)

Preset Display Modes

STANDARD		RESOLUTION	HORIZONTAL FREQUENCY(KHZ)	VERTICAL FREQUENCY(HZ)
IBM	DOS	720x400	31.469	70
	DOS	640x480	31.500	60
MAC	VGA	640x480	35.000	67
	SVGA	832x624	49.725	75
	SXGA	1152x870	67.500	75
VESA	VGA	640x480	31.469	60
		640x480	37.861	72
		640x480	37.500	75
	SVGA	800x600	35.156	56
		800x600	37.879	60
		800x600	48.077	72
		800x600	46.875	75
	XGA	1024x768	48.363	60
		1024x768	57.700	72
		1024x768	60.023	75
	SXGA	1152x864	67.500	75
		1280x960	60.000	60
		1280x960	75.000	75
		1280x1024	64.000	60
		1280x1024	77.900	72
	WXGA+	1440x900	55.500	60
	UXGA	1600x1200	75.000	60
	WSXGA	1680x1050	65.290	60
	WUXGA	1920x1200	74.000	60

APPENDIX (cont.)

Connector Pin Assignment

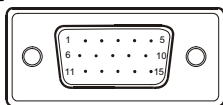

15 - Pin Color Display Signal Cable

PIN NO.	DESCRIPTION	PIN NO.	DESCRIPTION
1.	Video-Red	9.	+5V
2.	Video-Green	10.	Detect Cable
3.	Video-Blue	11.	NC
4.	NC	12.	DDC-Serial data
5.	Ground	13.	H-sync
6.	GND-R	14.	V-sync
7.	GND-G	15.	DDC-Serial clock
8.	GND-B		

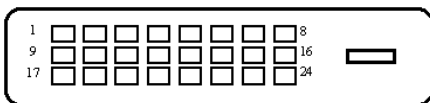

24 - Pin Color Display Signal Cable

PIN NO.	DESCRIPTION	PIN NO.	DESCRIPTION
1.	TMDS Data 2-	13.	TMDS Data 3+
2.	TMDS Data 2+	14.	+5V Power
3.	TMDS Data 2/4 Shield	15.	Ground(for+5V)
4.	TMDS Data 4-	16.	Hot Plug Detect
5.	TMDS Data 4+	17.	TMDS Data 0-
6.	DDC Clock	18.	TMDS Data 0+
7.	DDC Data	19.	TMDS Data 0/5 Shield
8.	NC	20.	TMDS Data 5-
9.	TMDS Data 1-	21.	TMDS Data 5+
10.	TMDS Data 1+	22.	TMDS Clock Shield
11.	TMDS Data 1/3 Shield	23.	TMDS Clock +
12.	TMDS Data 3-	24.	TMDS Clock -

Planar Systems, Inc

1195 NW Compton Drive
Beaverton, OR 97006-1992
www.planar.com

© 2007 Planar Systems, Inc.

Planar is a registered trademark of Planar Systems, Inc. Other brands and names are the property of their respective owners. Technical information in this document is subject to change without notice.



Q41G2401935 1A