



IX2851 LED LCD Monitor

USER'S GUIDE

www.planar.com

Planar utilizes HDMI® standards in this product.

The terms HDMI, HDMI High-Definition Multimedia Interface, HDMI Trade dress and the HDMI Logos are trademarks or registered trademarks of HDMI Licensing Administrator, Inc.

The information contained in this document is subject to change without notice. This document contains proprietary information that is protected by copyright. All rights are reserved. No part of this document may be reproduced, translated to another language or stored in a retrieval system, or transmitted by any means, electronic, mechanical, photocopying, recording, or otherwise, without prior written permission. Windows is a registered trademark of Microsoft Inc. Other brand or product names are trademarks of their respective holders.

| TABLE OF CONTENTS

FOR YOUR SAFETY.....	3
POUR VOTRE SÉCURITÉ.....	4
PRECAUTIONS	5
PRÉCAUTIONS	6
WEEE DECLARATION	7
SPECIAL NOTES ON LCD MONITORS	7
BEFORE YOU OPERATE THE MONITOR	8
FEATURES	8
PACKAGE LIST	8
INSTALLATION INSTRUCTIONS	9
ADJUSTING THE VIEWING ANGLE	10
CONTROLS AND CONNECTORS	11
OPERATING INSTRUCTIONS.....	12
GENERAL INSTRUCTIONS.....	12
FRONT PANEL CONTROL	13
HOW TO ADJUST A SETTING.....	14
ADJUSTING THE PICTURE.....	15
PLUG AND PLAY.....	17
TECHNICAL SUPPORT (FAQ)	18
TECHNICAL SUPPORT (FAQ).....	19
ERROR MESSAGE & POSSIBLE SOLUTION	19
APPENDIX.....	20
SPECIFICATIONS	20
FACTORY PRESET TIMING TABLE	21
CONNECTOR PIN ASSIGNMENT	22
WALL MOUNTING (OPTIONAL).....	25
PLANAR SUPPORT	26

| FOR YOUR SAFETY

Before operating the monitor, please read this manual thoroughly. This manual should be retained for future reference.

FCC Class B Radio Frequency Interference Statement

WARNING: (FOR FCC CERTIFIED MODELS)

NOTE: This equipment has been tested and found to comply with the limits for a Class B digital device, pursuant to Part 15 of the FCC Rules. These limits are designed to provide reasonable protection against harmful interference in a residential installation. This equipment generates, uses and can radiate radio frequency energy, and if not installed and used in accordance with the instructions, may cause harmful interference to radio communications. However, there is no guarantee that interference will not occur in a particular installation. If this equipment does cause harmful interference to radio or television reception, which can be determined by turning the equipment off and on, the user is encouraged to try to correct the interference by one or more of the following measures:

1. Reorient or relocate the receiving antenna.
2. Increase the separation between the equipment and receiver.
3. Connect the equipment into an outlet on a circuit different from that to which the receiver is connected.
4. Consult the dealer or an experienced radio/TV technician for help.

NOTICE:

1. The changes or modifications not expressly approved by the party responsible for compliance could void the user's authority to operate the equipment.
2. Shielded interface cables and AC power cord, if any, must be used in order to comply with the emission limits.
3. The manufacturer is not responsible for any radio or TV interference caused by unauthorized modification to this equipment. It is the responsibilities of the user to correct such interference.

WARNING:

To prevent fire or shock hazard, do not expose the monitor to rain or moisture. Dangerously high voltages are present inside the monitor. Do not open the cabinet. Refer servicing to qualified personnel only.

| POUR VOTRE SÉCURITÉ

Avant d'utiliser le moniteur, veuillez lire attentivement le présent manuel. Ce manuel doit être conservé pour référence future.

Déclaration FCC d'interférence de radiofréquence classe B **AVERTISSEMENT : (POUR LES MODÈLES CERTIFIÉS FCC)**

REMARQUE : Cet équipement a été testé et déclaré conforme aux limites d'un appareil numérique de classe B, conformément à la partie 15 de la réglementation de la FCC. Ces limites sont conçues pour offrir une protection raisonnable contre les interférences nuisibles dans une installation résidentielle. Cet équipement génère, utilise et peut émettre de l'énergie de radiofréquence, et s'il n'est pas installé et utilisé conformément aux instructions, peut provoquer des interférences nuisibles aux communications radio. Cependant, il n'est pas garanti qu'aucune l'interférence ne se produira pas dans une installation particulière. Si cet appareil provoque des interférences nuisibles à la réception de la radio ou de la télévision, ce qui peut être déterminé en mettant l'appareil hors tension puis sous tension, l'utilisateur est invité à essayer de corriger l'interférence par une ou plusieurs des mesures suivantes :

1. Réorienter ou déplacer l'antenne de réception.
2. Augmenter la distance entre l'équipement et le récepteur.
3. Brancher l'appareil sur une prise d'un circuit différent de celui auquel le récepteur est connecté.
4. Consulter le revendeur ou un technicien radio / TV expérimenté.

AVIS :

1. Les changements ou modifications non expressément approuvés par la partie responsable de la conformité peuvent annuler l'autorisation de l'utilisateur à faire fonctionner l'équipement.
2. Il faut utiliser des câbles d'interface et un cordon d'alimentation secteur blindés, le cas échéant, dans le but de se conformer aux limites d'émission.
3. Le fabricant n'est pas responsable des interférences radio ou TV provoquées par une modification non autorisée de cet équipement. Il est de la responsabilité de l'utilisateur de corriger de telles interférences.

AVERTISSEMENT :

Pour éviter un incendie ou un choc électrique, ne pas exposer le moniteur à la pluie ni à l'humidité. Des hautes tensions dangereuses sont présentes à l'intérieur du moniteur. Ne pas ouvrir le boîtier. Confiez l'entretien à un personnel qualifié uniquement.

PRECAUTIONS

- Do not use the monitor near water, e.g. near a bathtub, washbowl, kitchen sink, laundry tub, swimming pool or in a wet basement.
- Do not place the monitor on an unstable cart, stand, or table. If the monitor falls, it can injure a person and cause serious damage to the appliance. Use only a cart or stand recommended by the manufacturer or sold with the monitor. If you mount the monitor on a wall or shelf, use a mounting kit approved by the manufacturer and follow the kit instructions.
- Slots and openings in the back and bottom of the cabinet are provided for ventilation. To ensure reliable operation of the monitor and to protect it from overheating, be sure these openings are not blocked or covered. Do not place the monitor on a bed, sofa, rug, or similar surface. Do not place the monitor near or over a radiator or heat register. Do not place the monitor in a bookcase or cabinet unless proper ventilation is provided.
- The monitor should be operated only from the type of power source indicated on the label. If you are not sure of the type of power supplied to your home, consult your dealer or local power company.
- The monitor is equipped with a three-pronged grounded plug, a plug with a third (grounding) pin. This plug will fit only into a grounded power outlet as a safety feature. If your outlet does not accommodate the three-wire plug, have an electrician install the correct outlet, or use an adapter to ground the appliance safely. Do not defeat the safety purpose of the grounded plug.
- Unplug the unit during a lightening storm or when it will not be used for long period of time. This will protect the monitor from damage due to power surges.
- Do not overload power strips and extension cords. Overloading can result in fire or electric shock.
- Never push any object into the slot on the monitor cabinet. It could short circuit parts causing a fire or electric shock. Never spill liquids on the monitor.
- Do not attempt to service the monitor by yourself; opening or removing covers can expose you to dangerous voltages and other hazards. Please refer all servicing to qualified service personnel.
- To ensure satisfactory operation, use the monitor only with UL listed computers which have appropriate configured receptacles marked between 100 - 240V AC, Min. 5A.
- The wall socket shall be installed near the equipment and shall be easily accessible.

PRÉCAUTIONS

- Ne pas utiliser le moniteur près de l'eau, par exemple près d'une baignoire, d'un lavabo, d'un évier, d'un bac à linge, d'une piscine ou dans un sous-sol humide.
- Ne pas placer le moniteur sur un chariot, un support ou une table. Si le moniteur tombe, il peut blesser quelqu'un et causer de graves dommages à l'appareil. Utiliser uniquement un chariot ou un support recommandé par le fabricant ou vendu avec le moniteur. Si vous montez le moniteur sur un mur ou sur une étagère, utilisez un kit de montage approuvé par le fabricant et suivez les instructions du kit.
- Les fentes et ouvertures au dos et au bas du boîtier sont prévues pour la ventilation. Pour assurer un fonctionnement fiable du moniteur et le protéger contre toute surchauffe, assurez-vous que ces ouvertures ne sont pas obstruées. Ne pas placer le moniteur sur un lit, un canapé, un tapis ou une surface similaire. Ne pas placer le moniteur près d'un radiateur ou d'un convecteur, ni dessus. Ne pas placer le moniteur dans une bibliothèque ou dans une armoire à moins qu'une ventilation adéquate ne soit prévue.
- Le moniteur ne doit être utilisé qu'avec le type de source d'alimentation indiqué sur l'étiquette. Si vous n'êtes pas certain du type d'alimentation de votre domicile, consultez votre revendeur ou la compagnie d'électricité locale.
- Le moniteur est équipé d'une prise de terre à trois broches, fiche standard avec une troisième broche (pour la terre). Cette fiche ne peut être insérée que dans une prise reliée à la terre, comme dispositif de sécurité. Si votre prise ne peut pas accueillir la fiche à trois fils, un électricien pour installer une prise appropriée, ou vous pouvez utiliser un adaptateur pour relier l'appareil à la masse en toute sécurité. Ne pas neutraliser le dispositif de sécurité que constitue la prise de terre.
- Débranchez l'appareil pendant les orages ou quand il n'est pas prévu de l'utiliser pendant une période prolongée. Cela permet de protéger l'écran contre les dommages dus aux surtensions.
- Ne pas surcharger les multiprises d'alimentation ni les rallonges. Une surcharge peut provoquer un incendie ou un choc électrique.
- Ne jamais enfoncer d'objet dans la fente du boîtier du moniteur. Cela pourrait mettre en court-circuit des pièces et provoquer un incendie ou un choc électrique. Ne jamais renverser de liquide sur le moniteur.
- Ne pas tenter de réparer le moniteur par vous-même; l'ouverture ou la dépose des capots peut vous exposer à des tensions dangereuses et à d'autres risques. Veuillez vous référer à du personnel de service qualifié pour toute réparation.
- Pour assurer un fonctionnement satisfaisant, utiliser le moniteur uniquement avec des ordinateurs agréés UL ayant des réceptacles de prises appropriés marqués entre 100 - 240V AC, Min. 5A.
- La prise secteur doit être installée près de l'équipement et rester facilement accessible.

WEEE DECLARATION

Disposal of Waste Equipment by Users in Private Household in the European Union.



This symbol on the product or on its packaging indicates that this product must not be disposed of with your other household waste. Instead, it is your responsibility to dispose of your waste equipment by handing it over to a designated collection point for the recycling of waste electrical and electronic equipment. The separate collection and recycling of your waste equipment at the time of disposal will help to conserve natural resources and ensure that it is recycled in a manner that protects human health and the environment. For more information about where you can drop off your waste equipment for recycling, please contact your local city office, your household waste disposal service or the shop where you purchased the product.

SPECIAL NOTES ON LCD MONITORS

The following symptoms are normal with LCD monitor and do not indicate a problem.

NOTES

- Due to the nature of the fluorescent light, the screen may flicker during initial use. Turn off the Power Switch and then turn it on again to make sure the flicker disappears.
- You may find slightly uneven brightness on the screen depending on the desktop pattern you use.
- The LCD screen has effective pixels of 99.99% or more. It may include blemishes of 0.01% or less such as a missing pixel or a pixel lit all of the time.
- Due to the nature of the LCD screen, an after image of the previous screen may remain after switching the image, when the same image is displayed for hours. In this case, the screen is recovered slowly by changing the image or turning off the Power Switch for hours.
- When the screen becomes black or flashing, or cannot illuminate any more, contact your dealer or service center to replace parts. Don't repair the screen by yourself!

| BEFORE YOU OPERATE THE MONITOR

FEATURES

- 28" (70.9 cm) TFT Color LCD Monitor
- Crisp, Clear Display for Windows
- Recommended Resolutions: 3840*2160@60Hz
- LED Backlight, energy efficient
- Ergonomic Design
- Space Saving, Compact Case Design

PACKAGE LIST

The product package should include the following items:

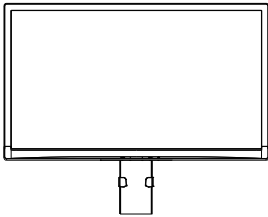

Monitor



Stand



User's Guide

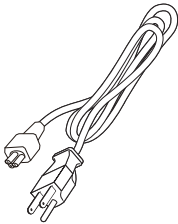

Power Cable

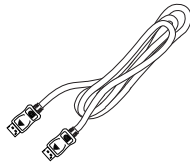

DP Cable

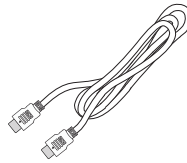

HDMI Cable

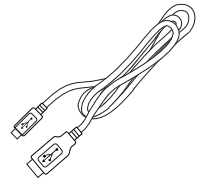

USB Cable

INSTALLATION INSTRUCTIONS

STAND BASE INSTALLATION

The monitor is supplied complete with a stand. If you prefer to wall mount the monitor, please follow the instructions on page 21 to remove the stand. Be sure to include the stand with the monitor if it is necessary to return the unit.

- CAUTION**
- Put the monitor on a stable surface. The monitor may cause injury or damage if it falls or is dropped.
 - Do not give a strong impact to the monitor. It may cause damage.
 - Unplug the monitor before removal or installation to avoid electric shock or damage.

<Installation>

1. Put a piece of soft cloth on the table beforehand to prevent the monitor from being scratched. Lay the monitor flat on a table with front face down. Turn the stand counter-clockwise.
2. Install the Stand-Base to the Monitor.
3. Fix the monitor to the stand by using the screw. Once screw is securely fastened, push down the knob on the screw.

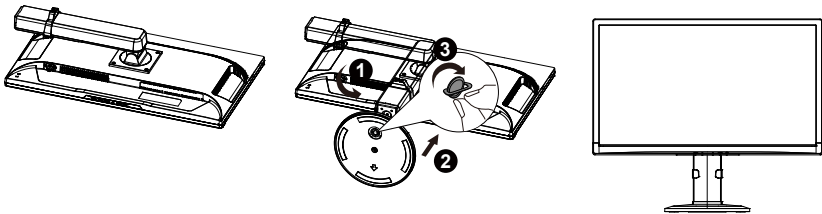

<Remove>

1. Put a piece of soft cloth on the table beforehand to prevent the monitor from being scratched. Lay the monitor flat on a table with front face down.
2. Pull up the knob of the screw, and remove the screw and the Stand-Base.

ADJUSTING THE VIEWING ANGLE

- For optimal viewing it is recommended to look at the full face of the monitor, then adjust the monitor's angle to your own preference.
- Hold the stand so you do not topple the monitor when you change the monitor's angle.
- You are able to adjust the monitor as below:

Tilt angle: $-5^{\circ} \sim 23^{\circ}$



Pivot angle: $0^{\circ} \sim 90^{\circ}$

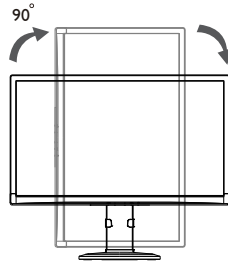

Swivel angle: $-160^{\circ} \sim 160^{\circ}$

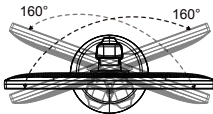

Height adjustment:

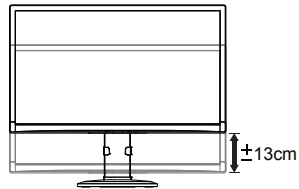

NOTES

- Do not touch the LCD screen when you change the angle. It may cause damage or break the LCD screen.
- Careful attention is required not to catch your fingers or hands when you change the angle.

CONTROLS AND CONNECTORS

POWER CORD

Power Source:

1. Make sure that the power cord is the correct type required in your area.
2. This LCD monitor has an internal universal power supply that allows operation in either 100/120V AC or 220/240V AC voltage area (No user adjustment is required.)
3. Connect the AC-power cord into your LCD monitor's power input socket, The AC-power cord may be connected to either a wall power outlet or the power outlet socket on your PC, depending on the type of power cord supplied with your LCD monitor.

SIGNAL CABLE

Connecting the Signal Cable : Plug one end of the signal cable to the LCD monitor and the other end to a computer or a video source.

Caution: If the AC outlet is not grounded (with three holes), install the proper grounding adapter (not supplied).

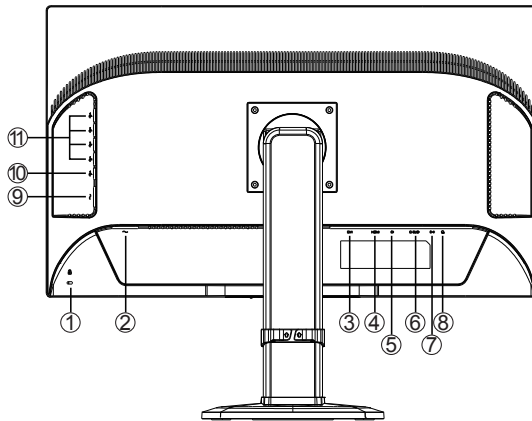

1.	Kensington anti-theft lock
2.	Power input
3.	DVI input
4.	HDMI input
5.	DP input
6.	D-SUB input
7.	Audio input
8.	Earphone jack
9.	Power Switch
10.	USB Cable (upstream)
11.	USB Cable*4(downstream)

| OPERATING INSTRUCTIONS

GENERAL INSTRUCTIONS

Press the power button to turn the monitor on or off. The other control buttons are located at front panel of the monitor. By changing these settings, the picture can be adjusted to your personal preferences.

- The power cord should be connected.
- Connect the video cable from the monitor to the video card.
- Press the power button to turn on the monitor. The power indicator will light up.

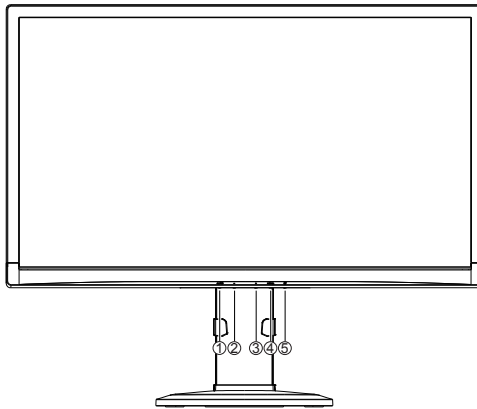

1.	Source/AutoAdjust/EXIT button
2.	ECO (-)
3.	Volume Hotkey/ Audio Source(+)
4.	Menu / Enter
5.	Power button

FRONT PANEL CONTROL

- **Power Button:**

Press this button to switch ON/OFF monitor's power.

- **Power Indicator:**

Blue — Power On mode.

Orange — Standby.

Off — Off mode.

- **MENU / ENTER :**

Activates OSD menu or function adjust confirm.

- **ECO/(-)**

Activates the ECO control when the OSD is OFF or navigate through adjustment icons when OSD is ON or adjust a function when function is activated.

- **Volume +/- :**

Activates the volume control and audio source when the OSD is off or navigate through adjustment icons when OSD is On or adjust a function when function is activated.

- **Source / Adjust / Exit**

When the OSD is off, pressing Auto/Source button will activate Source menu. Choose between sources, PIP/PBP sub source, DP 1.1 or 1.2, HDMI 1.4 or 2.0 using the +/- keys, turn on or off Auto Source. Press Menu/Enter button to change to the desired selection. Auto configure hot key: (VGA input only) When the OSD is off, press and hold own the button for 2 seconds to auto configure. When OSD menu is ON, this button will act as an Exit Key (Exit OSD menu)

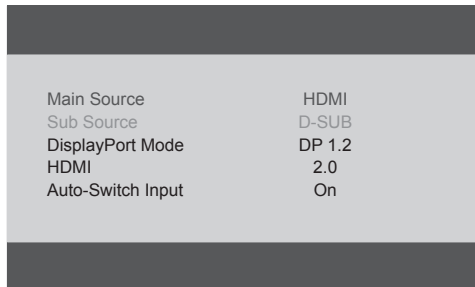

Main Source	HDMI
Sub Source	D-SUB
DisplayPort Mode	DP 1.2
HDMI	2.0
Auto-Switch Input	On

OSD Lock Function: Lock-All 4 buttons are locked except "POWER" button.

To lock the OSD, press and hold the MENU button while the monitor is off and then Press power button to turn the monitor on. To un-lock the OSD, press and hold the MENU button while the monitor is off and then press power button to turn the monitor on.

NOTES

- Do not install the monitor in a location near heat sources such as radiators or air ducts, or in a place subject to direct sunlight, or excessive dust or mechanical vibration or shock.



- Save the original shipping carton and packing materials, as they will come in handy if you ever have to ship your monitor.
- For maximum protection, repackage your monitor as it was originally packed at the factory.
- To keep the monitor looking new, periodically clean it with a soft cloth. Stubborn stains may be removed with a cloth lightly dampened with a mild detergent solution. Never use strong solvents such as thinner, benzene, or abrasive cleaners, since these will damage the cabinet. As a safety precaution, always unplug the monitor before cleaning it.
- Do not scratch the screen with hard things, it may cause permanent damage.
- Don't leak liquid into monitor which will result in the damage of component.



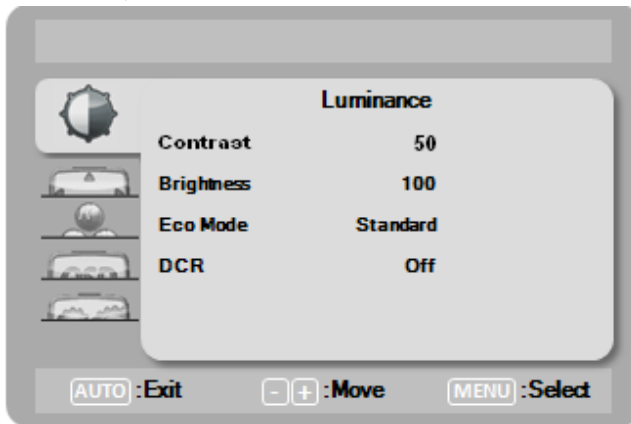

HOW TO ADJUST A SETTING

1. Press the MENU-button to activate the OSD window.
2. Press + or - to navigate through the functions. Once the desired function is highlighted, press the MENU-button to activate it. If the function selected has a sub-menu, press + or - again to navigate through the sub-menu functions. Once the desired function is highlighted, press MENU-button to activate it.
3. Press + or - to change the settings of the selected function.
4. If you want to adjust any other function, repeat steps 2-3.



ADJUSTING THE PICTURE

Main Menu Item	Main Menu Icon	1 st Sub Menu Item	Description
Luminance		Contrast	Adjusts Image brightness in relation to the background.
		Brightness	Adjusts backlight levels.
		Eco Mode	Picture Adjustment, Standard: Brightness = 90, Contrast = 50. Brightness, Contrast (Adjustable)
			Text: Brightness = 20, Contrast = 50. Brightness, Contrast ,Grayed. (Nonadjustable)
			Internet: Brightness = 40, Contrast = 50. Brightness, Contrast ,Grayed. (Nonadjustable)
			Game: Brightness = 60 Contrast = 50, Brightness, Contrast ,Grayed. (Nonadjustable)
			Movie: Brightness = 80, Contrast = 50, Brightness, Contrast ,Grayed. (Nonadjustable)
		Sports: Brightness = 100, Contrast = 50, Brightness, Contrast ,Grayed. (Nonadjustable)	
DCR	Dynamic contrast ratio.		
Image Setup		Clock	Adjust picture Clock to reduce Vertical-Line noise.
		Phase	Adjust Picture Phase to reduce Horizontal-Line noise.
		H. Position	Adjust the horizontal position of the picture.
		V. Position	Adjust the vertical position of the picture.
		Image Ratio	Select Image Aspect Ratio.

Main Menu Item	Main Menu Icon	1 st Sub Menu Item	Description
Color Temp.		Normal	Normal Color Temperature. (RGB value is nonadjustable)
		Warm	Warm Color Temperature. (RGB value is nonadjustable)
		Cool	Cool Color Temperature. (RGB value is nonadjustable)
		sRGB	RGB Color Temperature. (RGB value is nonadjustable)
		User	Adjust R.G.B levels as desired. User-R:Adjust Red Gain User-G:Adjust Green Gain User-B:Adjust Blue Gain
PIP/PBP		PIP/PBP Mode	Off: Stop Multi-View function PIP: Picture-in-Picture Mode PBP: Picture-by-Picture Mode
		PIP Size	Small: Small sub-window Middle: Middle sub-window Large: Large sub-window
		PIP Position	Right Up: Choose top-right position Right Down: Choose bottom-right position Left Up: Choose top-left position Left Down: Choose bottom-left position
		Swap	Swap main window and sub window.
		OSD Setup	
		Language	Set OSD display language .(English is default setting)
Extra		Input Select	Main Source: D-SUB/DVI/HDMI/DP Sub Source: D-SUB/DVI/HDMI/DP DisplayPort Mode: 1.1/1.2 HDMI: 1.4/2.0 Auto-Switch Input: On/Off
		DDC/CI	Select DDC/CI on or off.
		Reset	Set Monitor to default status.
		Information	Show the resolution, H/V frequency of current input timing.

PLUG AND PLAY

Plug & Play DDC2B Feature

This monitor is equipped with VESA DDC2B capabilities according to the VESA DDC STANDARD. It allows the monitor to inform the host system of its identity and, depending on the level of DDC used, communicate additional information about its display capabilities.

The DDC2B is a bidirectional data channel based on the I²C protocol. The host can request EDID information over the DDC2B channel.

THIS MONITOR WILL APPEAR TO BE NON-FUNCTIONAL IF THERE IS NO VIDEO INPUT SIGNAL. IN ORDER FOR THIS MONITOR TO OPERATE PROPERLY, THERE MUST BE A VIDEO INPUT SIGNAL.

This monitor meets the Green monitor standards as set by the Video Electronics Standards Association (VESA) and The Swedish Confederation Employees (NUTEK). This feature is designed to conserve electrical energy by reducing power consumption when there is no video-input signal present. When there is no video input signal this monitor, following a time-out period, will automatically switch to an OFF mode. This reduces the monitor's internal power supply consumption. After the video input signal is restored, full power is restored and the display is automatically redrawn. The appearance is similar to a "Screen Saver" feature except the display is completely off. The display is restored by pressing a key on the keyboard, or clicking the mouse.

USING THE RIGHT POWER CORD :

The accessory power cord for the Northern American region is the wallet plug with NEMA 5-15 style and is UL listed and CSA labeled. The voltage rating for the power cord shall be 125 volts AC.

Supplied with units intended for connection to power outlet of personal computer: Please use a cord set consisting of a minimum No. 18 AWG, type SJT or SVT three conductors flexible cord. One end terminates with a grounding type attachment plug, rated 10A, 250V, CEE-22 male configuration. The other end terminates with a molded-on type connector body, rated 10A, 250V, having standard CEE-22 female configuration.

Please note that power supply cord needs to use VDE 0602, 0625, 0821 approval power cord in European countries.

TECHNICAL SUPPORT (FAQ)

Problem & Question	Possible Solution
Power LED is not on	<ul style="list-style-type: none"> * Check if the Power Switch is in the ON position. * Power Cord should be connected.
No Plug & Play	<ul style="list-style-type: none"> * Check if the PC system is Plug & Play compatible. * Check if the Video Card is Plug & Play compatible . * Check if the D-15 plug pin of Video Cable is bent.
Picture is fuzzy	<ul style="list-style-type: none"> * Adjust the Contrast and Brightness Controls.
Picture bounces or a wave pattern is present in the picture	<ul style="list-style-type: none"> * Move electrical devices that may cause electrical interference.
The power LED is ON (orange) but there's no video or no picture.	<ul style="list-style-type: none"> * Computer Power Switch should be in the ON position. * Computer Video Card should be snugly seated in its slot. * Make sure monitor's video cable is properly connected to the computer. * Inspect monitor's video cable and make sure none of the pins are bent. * Make sure computer is operational by hitting the CAPS LOCK key on the keyboard while observing the CAPS LOCK LED.The LED should either turn ON or OFF after hitting the CAPS LOCK key.
Missing one of the primary colors (RED, GREEN, or BLUE)	<ul style="list-style-type: none"> * Inspect the monitor's video cable and make sure that none of the pins are bent.
Screen image is not centered or sized properly.	<ul style="list-style-type: none"> * Adjust pixel frequency (CLOCK) and FOCUS or press hot-key (AUTO).
Picture has color defects (white does not look white)	<ul style="list-style-type: none"> * Adjust RGB color or select color temperature.
Poor brightness or contrast	<ul style="list-style-type: none"> * When the brightness of the screen lowers after being used for a certain period and the function of the display is affected, send it to our authorized service center for repair.
Horizontal or vertical disturbances on the screen	<ul style="list-style-type: none"> * Use win 95/98/2000/ME/XP/Win 7/Win 8 shut-down mode Adjust CLOCK and FOCUS or perform hot- key (AUTO-key).

TECHNICAL SUPPORT (FAQ)

CLOCK (pixel frequency) controls the number of pixels scanned by one horizontal sweep. If the frequency is not correct, the screen shows vertical stripes and the picture has not correct width.

FOCUS adjusts the phase of the pixel clock signal. With a wrong phase adjustment the picture has horizontal disturbances in light picture.

ERROR MESSAGE & POSSIBLE SOLUTION

NO SIGNAL:

1. Check that the signal-cable is properly connected, if the connector is loose,tighten the connector's screws.
2. Check the signal-cable's connection pins for damage.

INPUT NOT SUPPORT:

Your computer has been set to unsuitable display mode, set the computer to display mode given in the following table.

APPENDIX

SPECIFICATIONS

LCD Panel	Panel Type	TFT Color LCD
	Panel Size	70.9cm(28")
	Pixel pitch(mm)	0.16(H) × 0.16(V)
	Max. Resolution	3840X2160
	Display Colors	1.073B
Frequency (H/V)	H-Frequency	30KHz – 99KHz (D-SUB/Dual-link DVI-D/HDMI) 30KHz – 160KHz (DisplayPort)
	V-Frequency	56Hz – 80Hz (D-SUB) 23Hz – 80KHz (Dual-link DVI-D/HDMI/DisplayPort)
Input	VGA	15-Pin D-Sub
	DVI	24-Pin Dual-link DVI-D
	HDMI	HDMI
	DisplayPort	DisplayPort
USB hub	USB 2.0	Black x 2
	USB 3.0	Blue x 1, Yellow x 1 (quick charge)
Audio	Audio in	1 x stereo audio in for PC (audio jack, 3.5 Ø)
	Speaker	3W x 2
Power	Power Supply	100-240VAC, 50/60Hz
	Consumption	65 watts (Typical), 105 watts (Maximum)
	Consumption Standby	< 0.5W
Plug & Play	VESA DDC1/2BTM	
Environmental Considerations	Operating Temp: 0°C to 40°C Storage Temp.: -25°C to 55°C Operating Humidity: 10% to 85% Storage Humidity: 5% to 93%	
Dimension (with base)	659.7(W)X555.4(H)X244.5(D)	
Weight (N. W.) (with base)	7.88kg	

Note: All specifications are subject to change without prior notice.

FACTORY PRESET TIMING TABLE

Preset Display Modes

STAND	RESOLUTION	HORIZONTAL FREQUENCY(kHz)	VERTICAL FREQUENCY(Hz)
VGA	640×480 @60Hz	31.469	59.940
	640×480 @67Hz	35.000	66.667
	640×480 @72Hz	37.861	72.809
	640×480 @75Hz	37.500	75.000
Dos-mode	720×400 @70Hz	31.469	70.087
SVGA	800×600 @56Hz	35.156	56.250
	800×600 @60Hz	37.879	60.317
	800×600 @72Hz	48.077	72.188
	800×600 @75Hz	46.875	75.000
Mac-Mode	832×624 @75Hz	49.725	74.550
XGA	1024×768 @60Hz	48.363	60.004
	1024×768 @70Hz	56.476	70.069
	1024×768 @75Hz	60.023	75.029
SXGA	1280x720@60Hz	44.772	59.855
	1280x960@60Hz	60.000	60.000
	1280x1024@60Hz	63.981	60.020
	1280x1024@75Hz	79.976	75.025
WSXGA	1440x900@60Hz	55.935	59.887
WSXGA+	1680x1050@60Hz	64.674	59.883
FULL HD	1920x1080@60Hz	67.500	60.000
QWHD	2560x1440@60Hz	88.786	59.900
UHD	3840x2160@30Hz	67.500	30.000
	3840x2160@60Hz	133.32	60.000

Note: For 2PBP, set your computer to a non-VESA standard timing of 1920 x 2160.

CONNECTOR PIN ASSIGNMENT

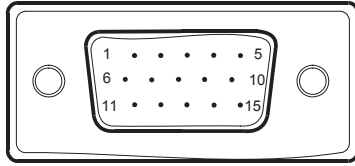

15 - Pin Color Display Signal Cable

PIN NO.	DESCRIPTION	PIN NO.	DESCRIPTION
1.	Red	9.	+5V
2.	Green	10.	Detect Cable
3.	Blue	11.	Ground
4.	Ground	12.	DDC-Serial Data
5.	Ground	13.	H-Sync
6.	R-Ground	14.	V-Sync
7.	G-Ground	15.	DDC-Serial Clock
8.	B-Ground		

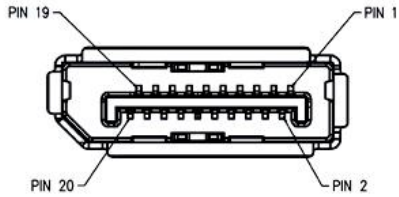

20-Pin Display Port Signal Cable

Pin No.	Mnemonic	Signal
1	ML Lane 3 (n)	Lane 3 -
2	GND	Ground
3	ML Lane 3 (p)	Lane 3 +
4	ML Lane 2 (n)	Lane 2 -
5	GND	Ground
6	ML Lane 2 (p)	Lane 2 +
7	ML Lane 1 (n)	Lane 1 -
8	GND	Ground
9	ML Lane 1 (p)	Lane 1 p
10	ML Lane 0 (n)	Lane 0 -
11	GND	Ground
12	ML Lane 0 (p)	Lane 0 +
13	GND	Ground
14	GND	Ground
15	AUX CH (p)	Aux Channel +
16	GND	Ground
17	AUX CH (n)	Aux Channel -
18	HPD	Hot Plug Detect
19	Return	Return
20	DP PWR	NC

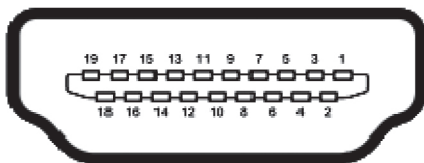

19 - Pin Color Display Signal Cable

PIN NO.	DESCRIPTION	PIN NO.	DESCRIPTION
1.	TMDS Data 2+	11.	TMDS Clock Shield
2.	TMDS Data 2 Shield	12.	TMDS Clock-
3.	TMDS Data 2-	13.	CEC
4.	TMDS Data 1+	14.	N.C.
5.	TMDS Data 1 Shield	15.	DDC SCL
6.	TMDS Data 1-	16.	DDC CLK
7.	TMDS Data 0+	17.	DDC/CEC Ground
8.	TMDS Data 0 Shield	18.	+5V Power (max 50mA)
9.	TMDS Data 0-	19.	Hot Plug Detect
10.	TMDS Clock+		

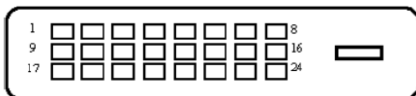

PIN NO.	DESCRIPTION	PIN NO.	DESCRIPTION
1	TMDS Data 2-	13	TMDS Data 3+
2	TMDS Data 2+	14	+5V Power
3	TMDS Data 2/4 Shield	15	Ground (for +5V)
4	TMDS Data 4-	16	Hot Plug Detect
5	TMDS Data 4+	17	TMDS Data 0-
6	DDC Clock	18	TMDS Data 0+
7	DDC Data	19	TMDS Data 0/5 Shield
8	NC	20	TMDS Data 5-
9	TMDS Data 1-	21	TMDS Data 5+
10	TMDS Data 1+	22	TMDS Clock Shield
11	TMDS Data 1/3 Shield	23	TMDS Clock +
12	TMDS Data 3-	24	TMDS Clock -

WALL MOUNTING (OPTIONAL)

Refer to the instructions that come with the base mounting kit. To convert your LCD display from a desk-mounted to a wall-mounted display, do the following:

1. Verify that the Power button is turned Off, then disconnect the power cord.
2. Lay the LCD display face down on a towel or blanket.
3. Remove the four screws attaching the base (Screw dimension: M4 x 14mm).
4. Attach the mounting bracket from the VESA compatible wall mounting kit (100 mm x 100 mm distance).
5. Attach the LCD display to the wall, following the instructions in the wall-mounting kit.

NOTE: For use only with Wall Mount Bracket with minimum weight/load: 12kg.

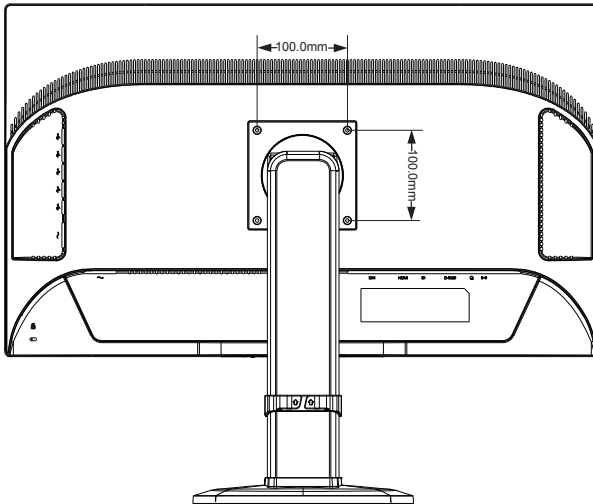

| PLANAR SUPPORT

Cables, Replacement Lamps, Accessories

To find cables, replacement lamps and accessories for your LCD monitor, touch screen or other Planar products visit our online store at www.PlanarOnline.com.

Technical Support

Visit Planar at <http://www.planar.com/support> for product registration, operations manuals, touch screen drivers, warranty information and access to Planar's Technical Library for online troubleshooting.

To speak with Planar Customer Support please have you model and serial number available and dial:

Planar Support

Tel: 1-866-PLANAR1 (866-752-6271) or +1 503-748-5799 outside the US.

Hours: 24 hours a day, 7 days a week.

Toll or long distance charges may apply.

Planar Systems, Inc.

Customer Service

24x7 Online Technical Support: <http://www.planar.com/support>

1195 NW Compton Drive

Beaverton, OR 97006-1992

Tel: 1-866-PLANAR1 (866-752-6271), or +1 503-748-5799 outside the United States,

Hours: 24 hours a day, 7 days a week

©2016 Planar Systems, Inc.

06/2016 Planar is a registered trademark of Planar Systems, Inc. Other brands and names are the property of their respective owners. Technical information in this document is subject to change without notice.



Q41G28M193501B