



PZN3815Q

LED LCD Monitor

USER'S GUIDE

www.planar.com

This document may not be copied in any form without permission from Planar. Information in this document is subject to change without notice.

Trademark Credits

Windows™ is a trademark of Microsoft Corp.

The terms HDMI®, HDMI High-Definition Multimedia Interface , HDMI Trade dress and the HDMI Logos are trademarks or registered trademarks of HDM Licensing Administrator, Inc. All other companies are trademarks or registered trademarks of their respective companies.

Disclaimer

The information contained in this document is subject to change without notice. Planar Systems, Inc. makes no warranty of any kind with regard to this material. While every precaution has been taken in the preparation of this manual, the Company shall not be liable for errors or omissions contained herein or for incidental or consequential damages in connection with the furnishing, performance, or use of this material.

Energy Star



ENERGY STAR is a program run by the U.S. Environmental Protection Agency (EPA) and U.S. Department of Energy (DOE) that promotes energy efficiency. This product qualifies for ENERGY STAR in the " factory default " settings and this is the setting in which power savings will be achieved. Changing the factory default picture settings or enabling other features will increase power consumption that could exceed the limits necessary to qualify for ENERGY STAR rating. For more information on the ENERGY STAR program, refer to energystar.gov.

Content

Operation Instructions	1
Unpacking Instructions	3
Safety Precautions	3
Consignes de sé curité	4
Package Overview	5
First Setup	6
Front View of the Product	8
Rear View of the Product	9
Installation	10
Basic Operation	12
OSD Menu	13
Supporting Timing Modes	20
Technical information	21
Wall-mounted installation instructions	22
Care and Maintenance	23
Troubleshooting	23
Planar Support	24

Operation Instructions

Thank you for purchasing the PZN3815Q monitor. Please read this guide thoroughly before installation.

FCC RADIO FREQUENCY INTERFERENCE STATEMENT WARNING: (FOR FCC CERTIFIED MODELS)

This LED LCD Monitor has been tested and found compliant with the limits for a Class B digital device, pursuant to part 15 of the FCC Rules. These limits are designed to provide proper protection against harmful interference to a residential installation. This LED LCD Monitor generates, uses, and can radiate radio frequency energy. Harmful interference to radio communication may be the result if it's not properly installed and used. However, there is no guarantee that interference will not occur in a particular installation. If this LED LCD Monitor does cause serious interference to radio or television reception, resetting may correct it. Moreover, users are encouraged to reduce interference by doing one or more of the following:

- Reorient or relocate the receiving antenna.
- Move the LED LCD Monitor and the receiver further away from each other.
- Connect the LED LCD Monitor into an outlet on a circuit different from that to which the receiver is connected.
- Consult your local dealer or a qualified technician.

FCC Warning:

To assure a continued FCC compliance, a user must use a grounded power supply cord and the provided shielded video interface cable with bonded ferrite cores. Also, any unauthorized changes or modifications to this LED LCD Monitor would void the user's authority to operate this device.

Note: If necessary, shielded interface cables and AC power cord must be used to meet the emission level limits.

Shielded cables must be used with this unit to ensure compliance with the Class B FCC limits.



According to WEEE regulation, this LED LCD Monitor can't be handled as normal trash in Europe when it is out of usage. Please refer to the recycle information on Planar's website to handle it.

For more information on how to recycle your product, please visit <http://www.planar.com/about/green/>

COMMUNIQUE D'AVERTISSEMENT DE LA FCC CONCERNANT LES INTERFERENCE DE FREQUENCE RADIO: (SEULEMENT POUR MODELES CERTIFIE PAR LA FCC)

Ce moniteur a été testé et a été trouvé conforme aux limites pour un appareil numérique de Class B, suivant la partie 15 des règlements de la FCC. Ces limites ont été développées pour offrir une protection satisfaisante contre les interférences nuisibles dans une installation résidentielle. Ce moniteur génère, utilise et peut radier de l'énergie de fréquence radio. Ceci peut causer des interférences nuisibles à des communications radio si l'appareil n'est pas convenablement installé et utilisé. Il n'y a néanmoins aucune garantie que des interférences n'apparaîtront pas dans une installation particulière. Si ce moniteur cause de sérieuses interférences à la réception de signaux radios ou télévisés, une possibilité est de réinitialiser le moniteur. Les usagers sont aussi encouragés à corriger les interférences en appliquant une ou plusieurs des démarches suivantes:

- Réorientez ou déplacez l'antenne de réception.
- Placez le moniteur et le récepteur plus loin l'un de l'autre.
- Connectez le moniteur à une prise différente de celle à laquelle le récepteur est connecté.
- Consultez votre revendeur local ou un technicien qualifié.

Avertissement de la FCC:

Pour assurer une conformité continue aux règlements de la FCC, l'utilisateur doit utiliser un cordon d'alimentation mis à terre et le câble d'interface vidéo protégé avec noyaux en ferrite, fourni avec l'appareil. Chaque modification ou changement non-autorisé appliqué à ce moniteur peut faire perdre à l'utilisateur son droit d'opération de cet appareil.

Note: Si nécessaire, des câbles d'interface protégés et un cordon d'alimentation alternante doivent être utilisés pour être conforme aux limites d'émission.

Des câbles blindés doivent être utilisés avec cet appareil pour assurer la conformité aux limites FCC Class B.

Unpacking Instructions

- Remove the LED LCD Monitor out of the package and take off EPS Foam.
- Remove stand and base from EPS Foam and attach to base.
- Adjust the display between -5° and 15° .

Safety Precautions

Follow all warnings, precautions and maintenance as recommended in this user's manual to maximize the life of your unit.

DO :

- Turn off the product before cleaning.
- Surface may be cleaned using a soft clean cloth moistened with mild window glass commercial cleaners or 50/50 mixture of water and isopropyl alcohol.
- Use a soft cloth moistened with mild detergent to clean the display housing.
- Disconnect the power plug from AC outlet if the product is not going to be used for an extended period of time.

Don't :

- Do not touch the LED display screen surface with sharp or hard objects.
- Do not use abrasive cleaners, waxes or solvents for your cleaning.
- Do not operate the product under the following conditions:
 - Over 16 hours per day.
 - Extremely hot, cold or humid environment.
 - Areas susceptible to excessive dust and dirt.
 - Near any appliance generating a strong magnetic field.
 - In direct sunlight.
- If smoke, abnormal noise or odor emits from your LED LCD Monitor, remove the power cord immediately and call your service center.
- Never remove the rear cover of your LED LCD Monitor. The display unit inside contains high-voltage parts and may cause electric shock.
- Never try to repair your LED LCD Monitor yourself. Always call your service center or a qualified technician to fix it.
- Due to safety concerns, if the VESA mounting kit is purchased separately, please make sure the mounting kit is UL-listed, and replaceable only by service personnel.

Consignes de sécurité

Respectez tous les avertissements, les précautions et conseils d'entretien recommandés dans ce manuel de l'utilisateur pour maximiser la durée de vie de votre appareil.

A faire:

- Éteindre le produit avant de le nettoyer.
- La surface de l'écran tactile peut être nettoyée avec un chiffon doux et propre imprégné d'un nettoyant doux du commerce pour vitres ou d'un mélange à 50/50 d'alcool isopropylique et d'eau.
- Utilisez un chiffon doux imprégné d'un détergeant doux pour nettoyer le carter de l'affichage.
- Débranchez la fiche d'alimentation de la prise de courant secteur si le produit ne doit pas être utilisé pendant une période prolongée.

A ne pas faire:

- Ne touchez pas la surface de l'écran LED avec des objets coupants ou durs.
- N'utilisez pas des produits de nettoyage abrasifs, de la cire ou des solvants pour le nettoyage.
- N'utilisez pas le produit dans les conditions suivantes:
 - Plus de 16 heures par jour.
 - Environnement extrêmement chaud, froid ou humide.
 - Endroits poussiéreux ou sales.
 - Près d'appareils générant un fort champ magnétique.
 - Sous la lumière directe du soleil.
- Si de la fumée, un bruit anormal ou une odeur s'échappait de votre moniteur LCD LED, débranchez immédiatement le cordon d'alimentation et appelez votre centre de réparation.
- Ne retirez jamais le couvercle arrière de votre moniteur LCD LED. L'unité d'affichage contient des éléments où circule un voltage élevé et présentant un risque d'électrocution.
- N'essayez jamais de réparer vous-même votre moniteur LCD LED. Faites toujours appel à votre centre de service ou à un technicien qualifié pour toute réparation.
- Pour des raisons de sécurité, si vous achetez séparément le kit de fixation VESA, assurez-vous que celui-ci est certifié UL, et qu'il peut être remplacé uniquement par un technicien qualifié.

Package Overview

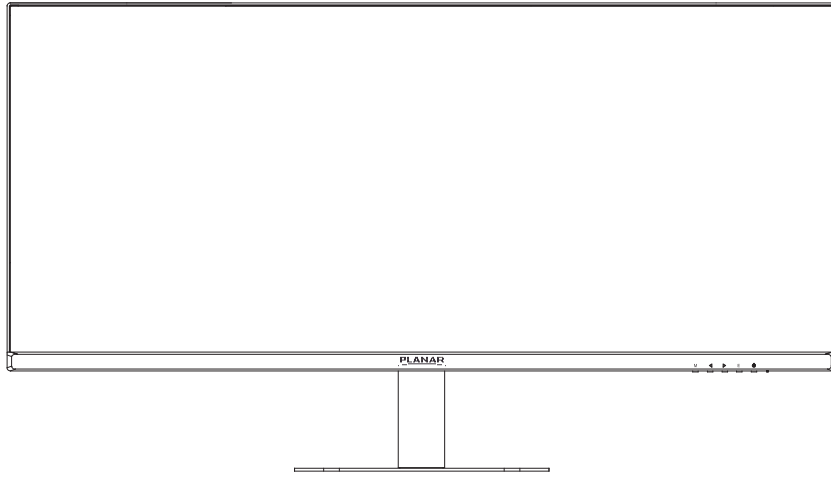

LED LCD Monitor

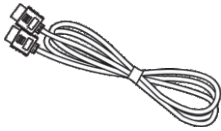

HDMI® Cable



USB-C Cable(100W)



Power Cord



DP Cable

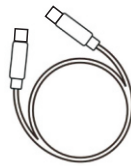

USB-A to USB-B Cable

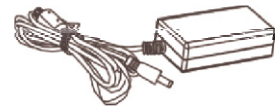

Adaptor



User's Guide

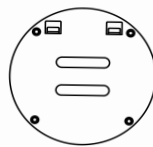

VESA plate adapter

First Setup

Install the Stand Base

1. Use included styrofoam to lay the monitor down.
2. Insert Stand into the monitor, then plug in Base to Stand to secure, as shown below.
3. Stand the LED LCD Monitor up

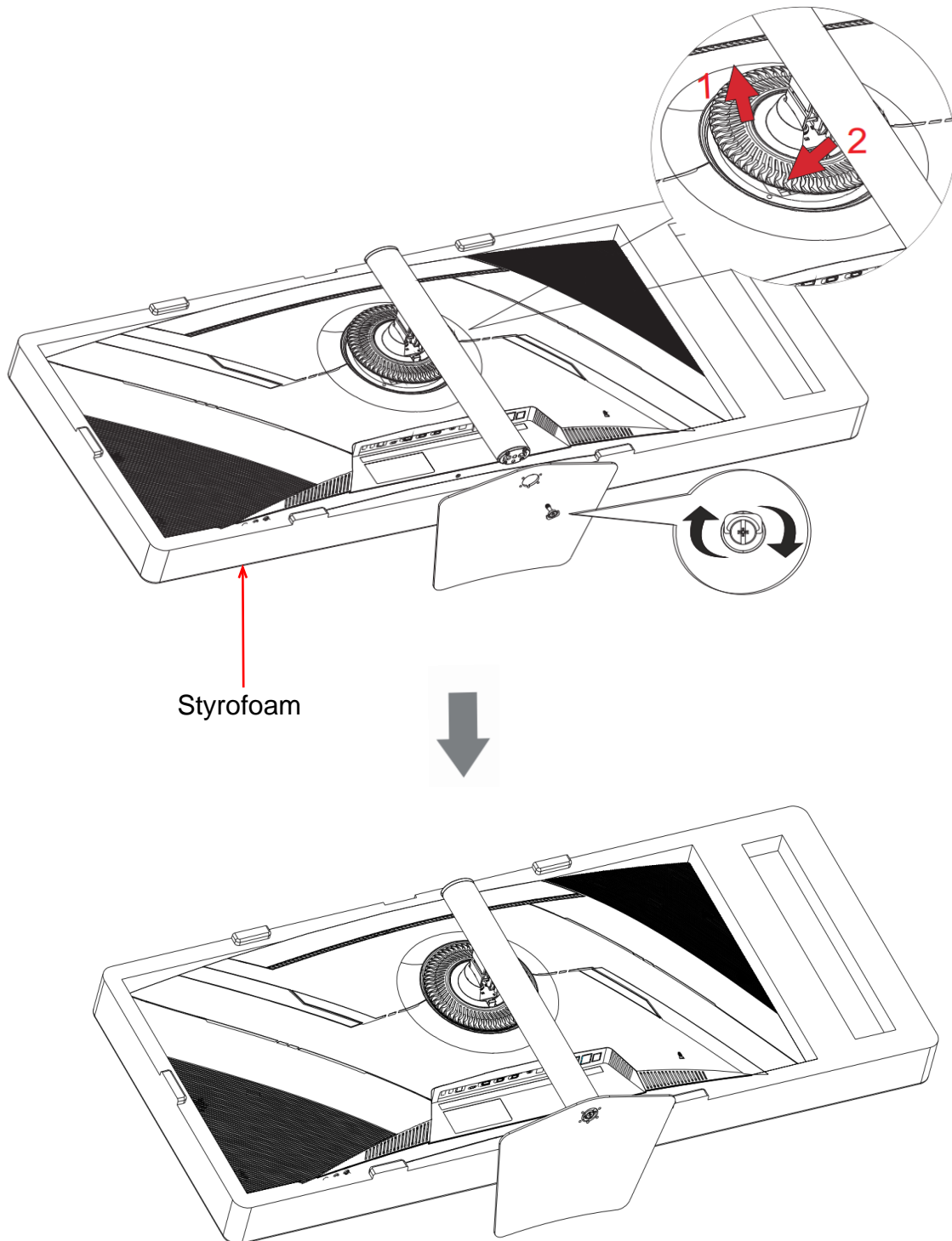

Disconnecting the Stand Base

1. Lay the LED LCD Monitor flat on a table with the LED screen face down. To prevent the LED LCD Monitor from being scratched, put a piece of soft cloth or cushion on the table on which the screen will be set.
2. Press the release button and pull away the monitor to remove the stand from the monitor.
3. Pull the release lever and pull away to remove base from stand.

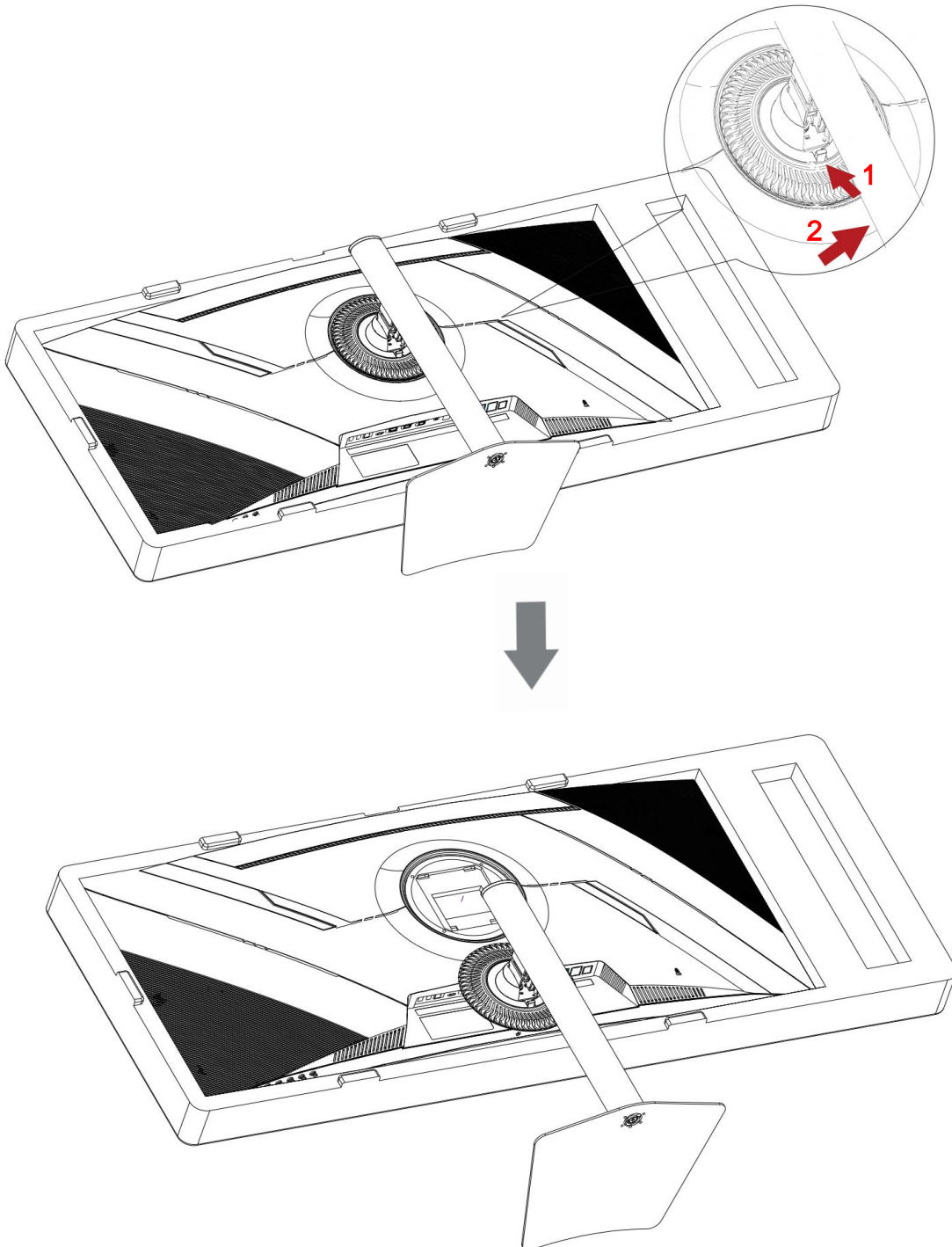

Front View of the Product

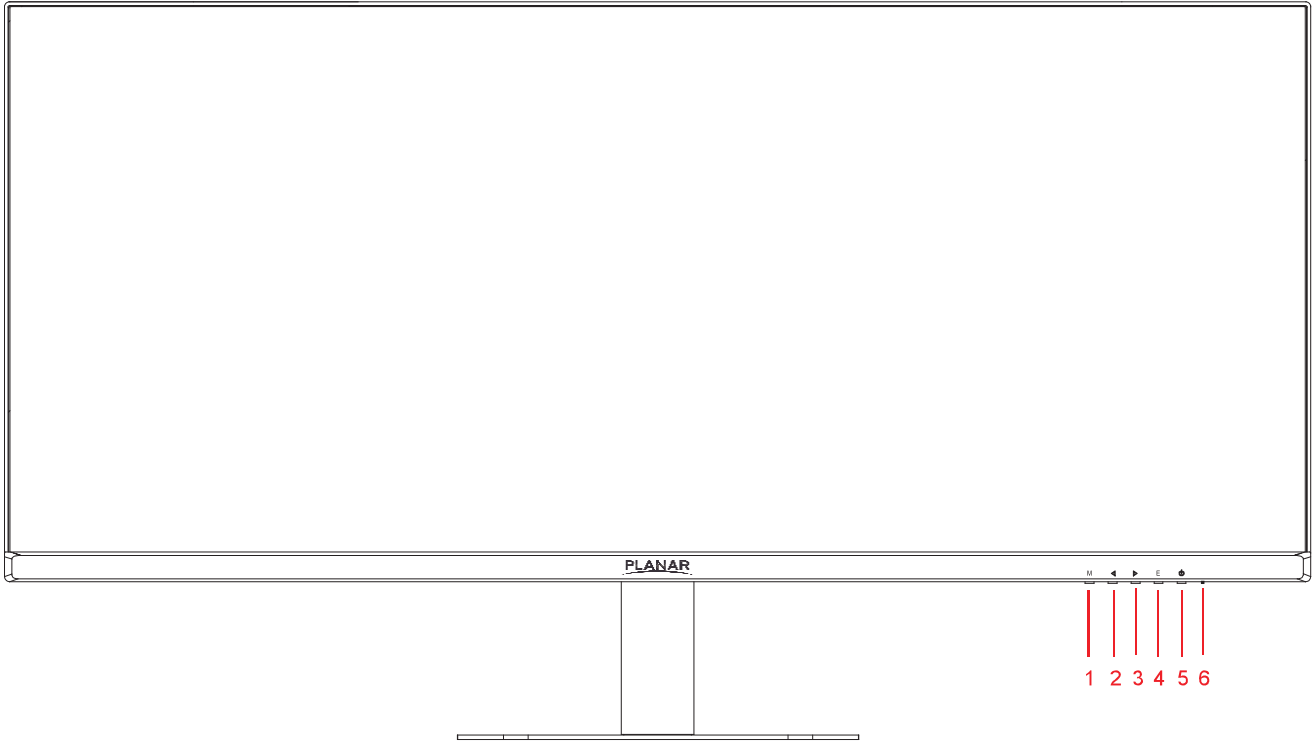

The symbols on the front correspond to the buttons on the bottom.

1	Menu / Exit
2	PIP/PBP / PXP Audio input / Down
3	Volume / KVM Toggle / Up
4	Input select / Enter
5	Power On / Off
6	LED Indicator

Rear View of the Product

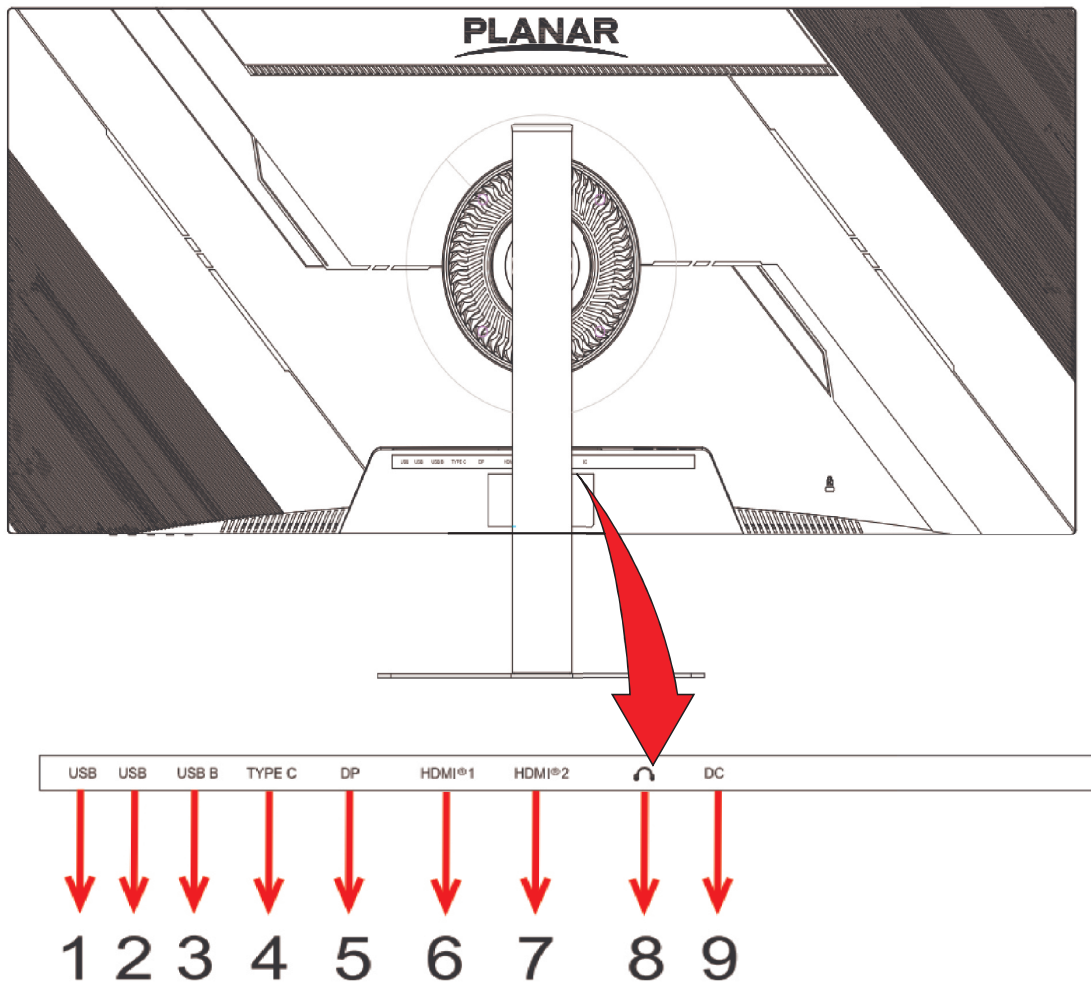

- 1 USB (USB Gen3.2 Gen1)
- 2 USB (USB Gen3.2 Gen1)
- 3 USB (USB Gen3.2 Gen1)
- 4 USB-C (96W)
- 5 DP
- 6 HDMI
- 7 HDMI
- 8 EARPHONE AUDIO
- 9 DC

Installation

1. Connect either USB-C, HDMI or DP Video Source from the monitor to the computer. Make sure both monitor and computer are powered OFF.
Note: In order to power the connected device (laptop, phone, tablet) via Type-C cable, a 100W Type-C cable is required. This monitor ships with a 100W USB-C cable.
2. Connect power adaptor to DC input of the monitor.
3. Connect power cord to a properly grounded AC outlet, and then to the adaptor.
4. Set the timing mode on your computer. Recommended resolution and refresh rate is 3840*1600 @75Hz.
5. The KVM switch allows you to control two separate PCS with one monitor-keyboard-mouse setup.

Connect both USB upstream cables from 2 different PCs, one to the USB Type C port, the other to the USB type B port. Connect USB peripherals to the USB A (Downstream) ports to the monitor. See figure below.

See page 12 and 19 on how to toggle KVM inputs.

Figure 1:

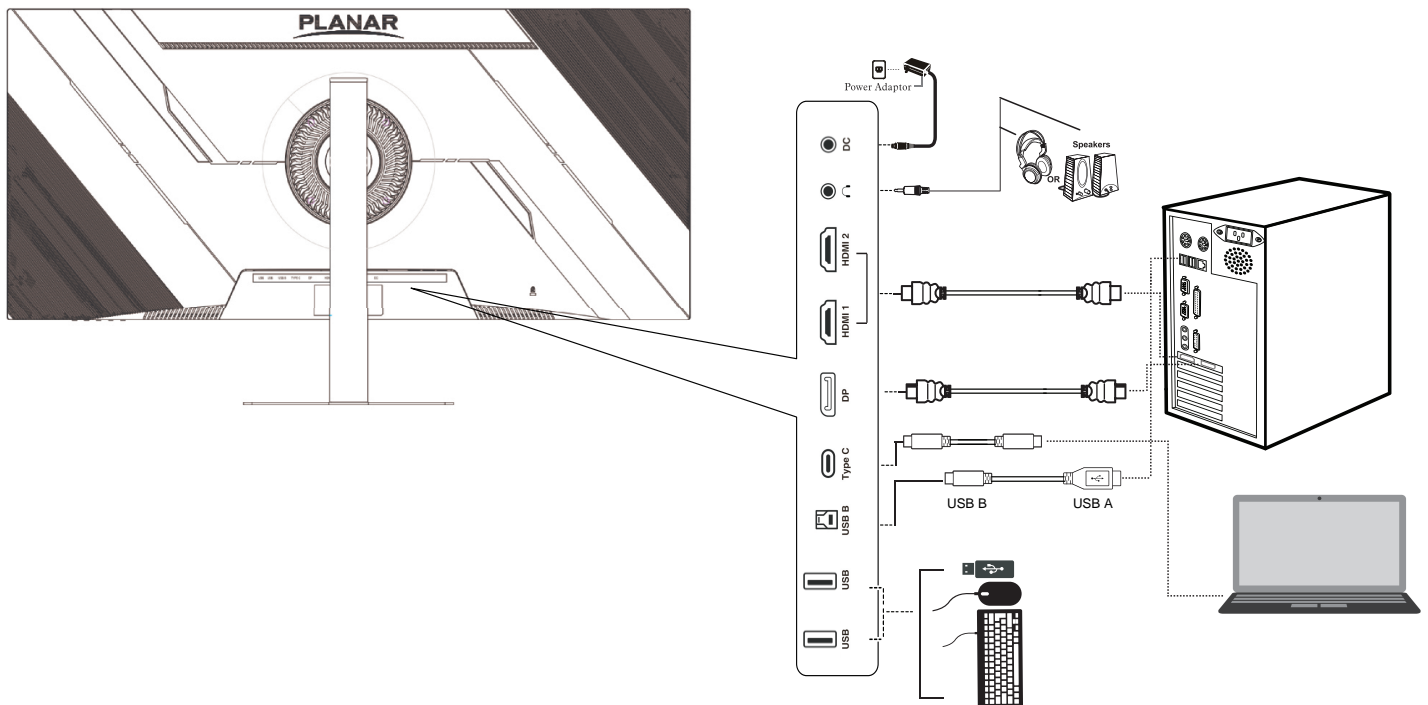

To comply with International energy standards, the USB hub/ports of this display are disabled by default. Connected USB devices will not work in this state.

To permanently put the USB function in "ON" state, please go to OSD Menu, then select "USB Charge" and switch it to "ON" state. In OSD-->MISC-->USB Charge-->On/Off

ADJUSTING THE VIEWING ANGLE

- For optimal viewing it is recommended to look at the full face of the monitor, then adjust the monitor's angle to your own preference.
- Hold the stand so you do not topple the monitor when you change the monitor's angle.
- You are able to adjust the monitor's swivel from -30° to 30° .
- You are able to adjust the monitor's tilt from -5° to 15° .

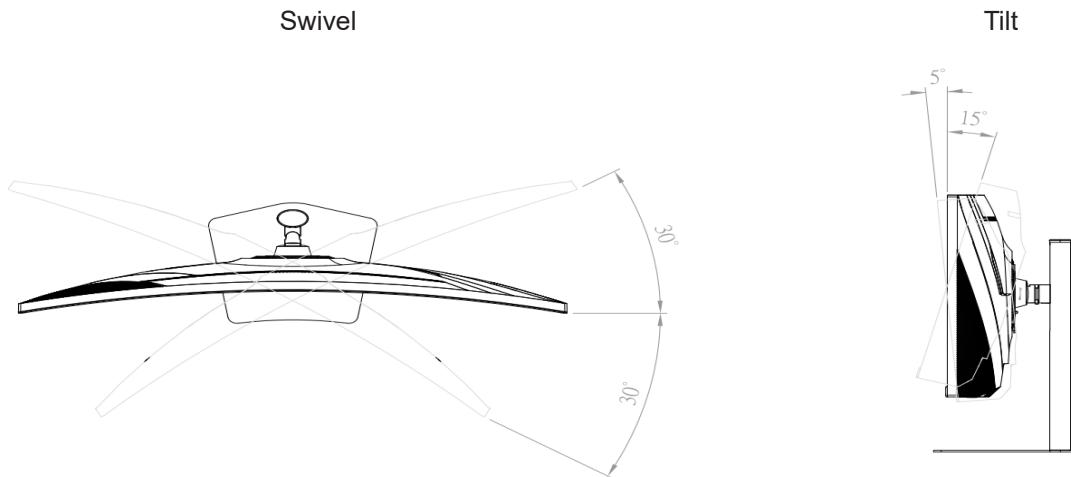

NOTES

- Do not touch the screen when you change the angle. It may cause damage or break the screen.
- Careful attention is required not to catch your fingers or hands when you change the angle.

Basic Operation

- **Power Button:**
Press this button to switch ON/OFF monitor's power.
- **Power Indicator:**
Blue —Power on mode.
Orange — Power saving mode.

[M]: Menu / Exit:
Activates OSD menu or exit selection.

◀: Down

When OSD is Off, short press activates the PIP/PBP toggle while long press activates the PXP Audio Input toggle. Use the up/down arrow to select and [E] to confirm selection.

When OSD is ON, it navigates through adjustment icons adjust a function when function is activated.

▶: Up

When OSD is Off, short press activates the volume while long press activates the KVM toggle. Use the up/down arrow to select and [E] to confirm selection.

When OSD is ON, it navigates through adjustment icons adjust a function when function is activated.

[E]: Input Select / Enter:

When the OSD is OFF, pressing [E] button will call out input select. Use the up/down arrow to select input. Press [E] to confirm selection.

OSD Lock Function: All 4 buttons are locked except Power button. Hold the [M] button for 5 seconds to lock/unlock.

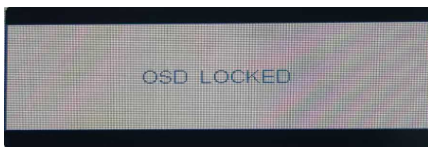

Power & OSD Lock Function: All 5 buttons including the Power button are locked. Hold the [E] for 5 seconds to lock/unlock.

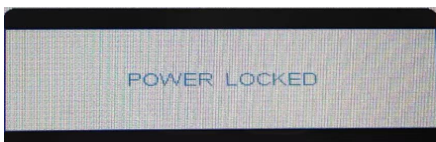

OSD Menu

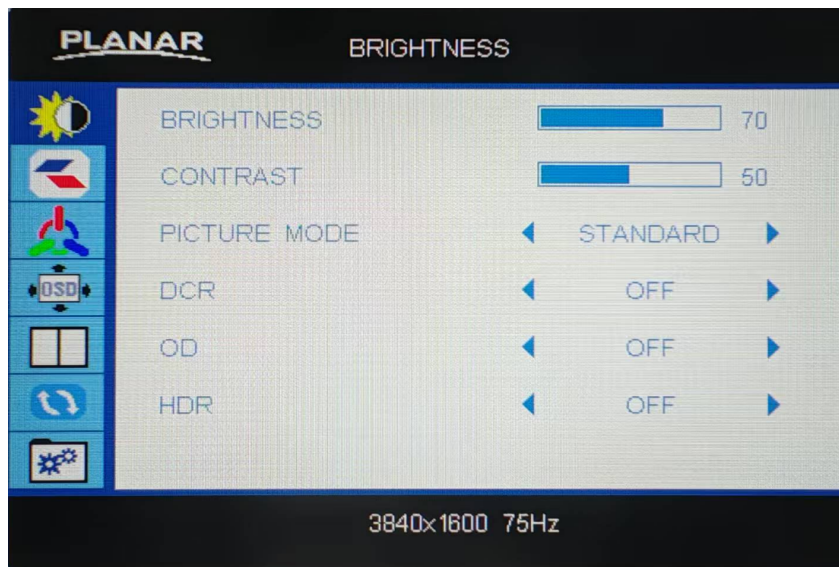

BRIGHTNESS

- **BRIGHTNESS:**
Adjust between 0 - 100 .
- **CONTRAST:**
Adjust between 0 - 100 .
- **PICTURE MODE:**
STANDARD, MOVIE, GAME, TEXT, MONO
- **DCR:**
ON/OFF
- **OC:**
ON/OFF
- **HDR:**
ON/OFF

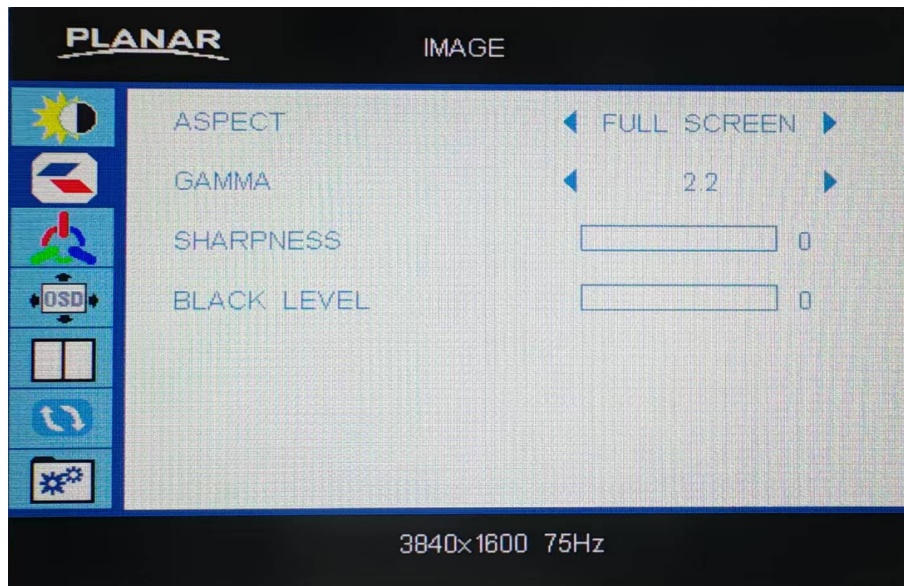

IMAGE

- **ASPECT :**
FULL SCREEN, 16:10, 16:9, 5:4, 4:3
- **GAMMA :**
1.8, 2.0, 2.2, 2.4
- **SHARPNESS:**
0-20
- **BLACK LEVEL (Brightens dark image)**
0-20

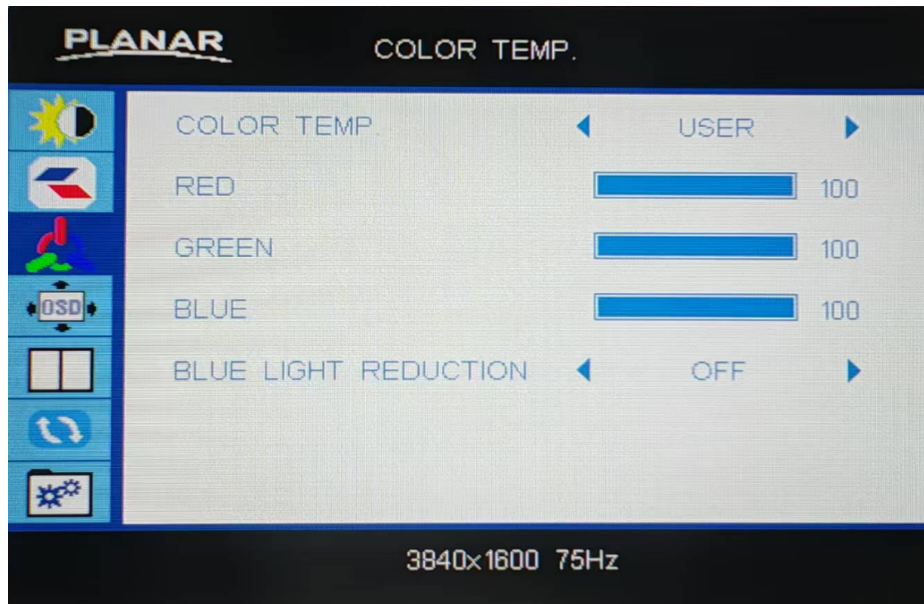

COLOR TEMP

- **COLOR TEMP :**

User, 5400K, 6500K, 9300K

Under USER, the following colors can be adjusted

- **R : Red**

1-100

- **G : Green**

1-100

- **B : Blue**

1-100

- **BLUE LIGHT REDUCTION:**

OFF

LEVEL1 (15% reduction) - VIDEO - Ideal for watching videos

LEVEL2 (30% reduction) - WEB BROWSING - Ideal for web browsing

LEVEL3 (50% reduction) - READING - Ideal for reading

LEVEL4 (70% reduction) - LOW LIGHT - Ideal for low ambient lighting environments.

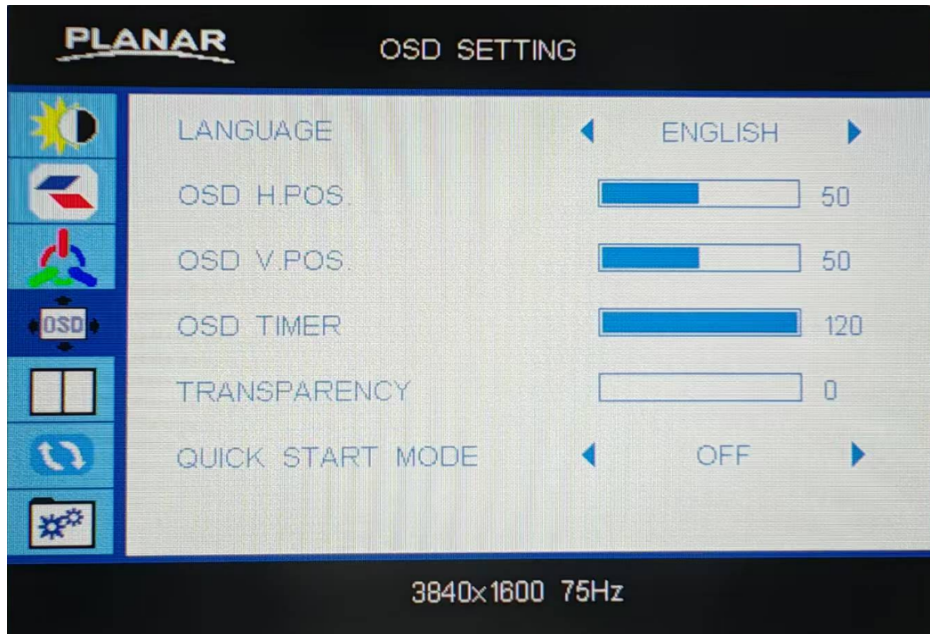

OSD SETTING

- **LANGUAGE :**
English, French, German, Italian, Spanish, Finnish, Japanese, Simplified Chinese
Traditional Chinese , Korean
- **OSD H. POS :**
0~100
- **OSD V. POS :**
0~100
- **OSD TIMER :**
10~120
- **TRANSPARENCY:**
0~10
- **QUICK START MODE (Splash screen is skipped when On):**
OFF/ON

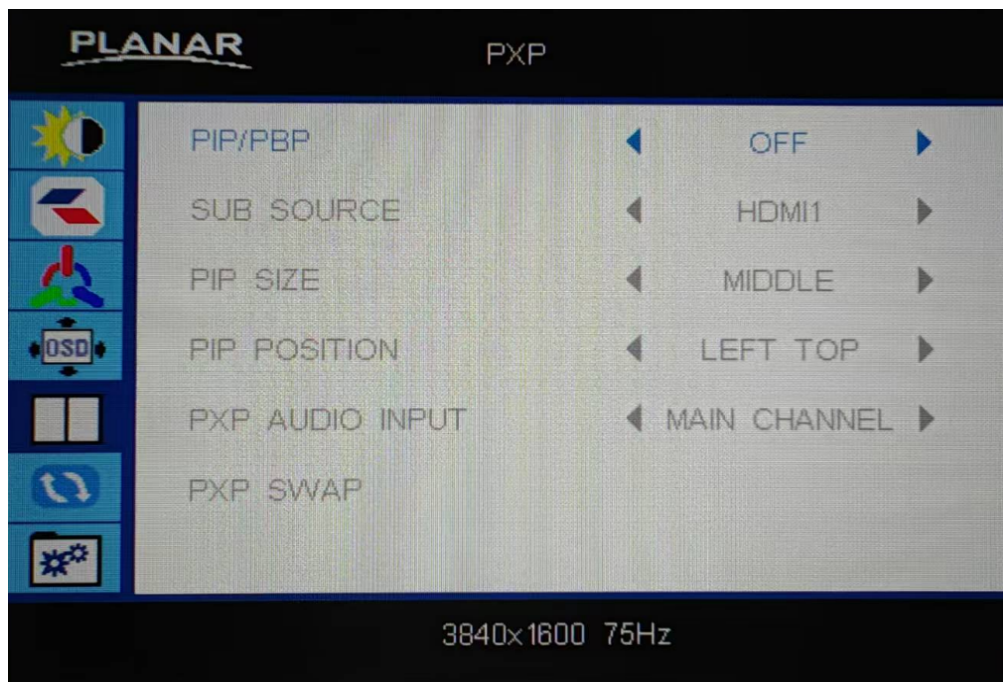

PIP (Picture-in-Picture): The sub source signal is displayed with the main source signal.

Resolution for PIP window are as follows:

Small: 800 x 600

Middle: 1024 x 768

Large: 1280 x 800

PBP (Picture-by-Picture): The main source and the sub source signals are displayed side by side with equal display sizes.

- **PIP/PBP:**
OFF / PIP / PBP
- **SUB SOURCE:**
HDMI1 / HDMI2 / USB-C / DP
- **PIP SIZE:**
SMALL / MIDDLE / LARGE
- **PIP POSITION:**
LEFT TOP / LEFT BOTTOM / RIGHT TOP / RIGHT BOTTOM
- **PXP AUDIO INPUT BOTTOM:**
MAIN CHANNEL / SUB CHANNEL
- **PXP SWAP:**
Swaps primary and sub source inputs

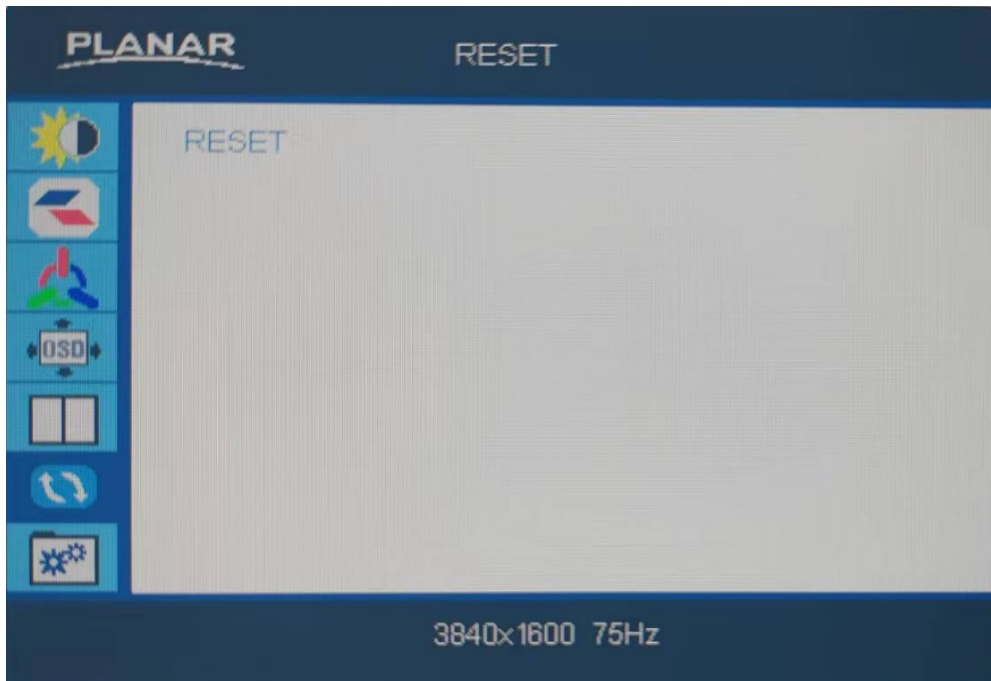

RESET

- RESET : Reset to factory default

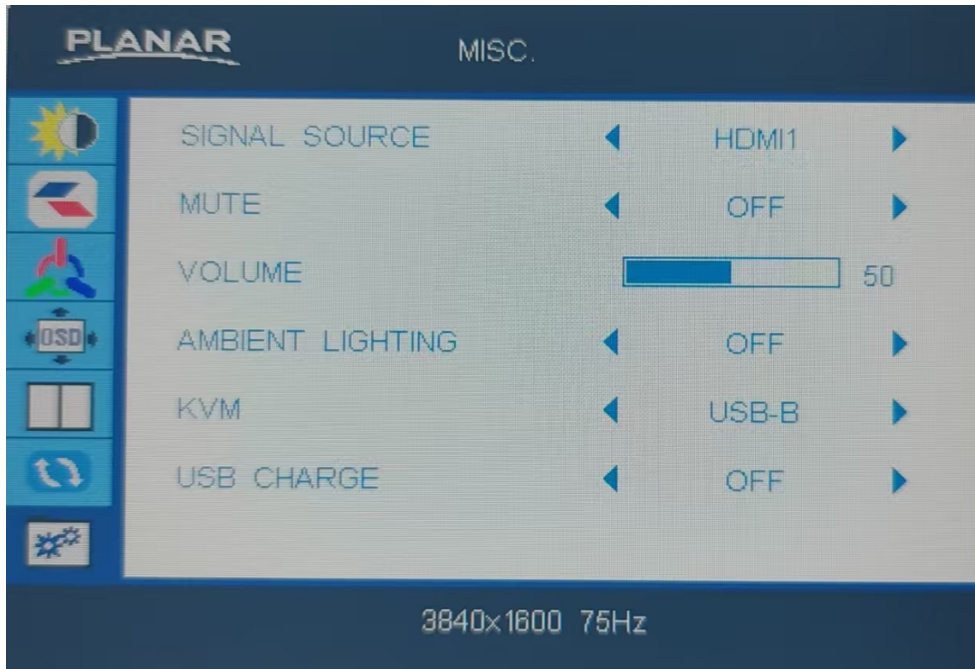

MISC

- **SIGNAL SOURCE :**
HDMI1 ,HDMI2, TYPE-C,DP
- **MUTE:**
OFF , ON
- **VOLUME :**
0-100
- **Ambient Lighting:**
OFF, YELLOW, PURPLE, CYAN, BLUE, GREEN, RED, SPECTRUM,
BREATHE YELLOW, BREATHE PURPLE, BREATHE CYAN, BREATHE
BLUE, BREATHE GREEN, BREATHE RED, BREATHE SPECTRUM
- **KVM :**
USB-C,USB-B
- **USB CHARGE:**
OFF / ON

Note: USB Charge is off by default. Turn On to use USB hub.

- **SERIAL NO.:**
Monitor serial number.

Supporting Timing Modes

Preset HDMI/Displayport/Type C Modes				
Standard	Resolution (Hz)	TYPE-C	HDMI	DP
VGA	640 × 480 @ 60	V	V	V
VGA	640 × 480 @ 67	V	V	V
VGA	640 × 480 @ 72	V	V	V
VGA	640 × 480 @ 75	V	V	V
SVGA	800 × 600 @ 56	V	V	V
SVGA	800 × 600 @ 60	V	V	V
SVGA	800 × 600 @ 72	V	V	V
SVGA	800 × 600 @ 75	V	V	V
XGA	1024 × 768 @ 60	V	V	V
XGA	1024 × 768 @ 70	V	V	V
XGA	1024 × 768 @ 75	V	V	V
XGA+	1152 × 864 @ 60	V	V	V
XGA+	1176 × 864 @ 60	V	V	V
SXGA	1280 × 720 @ 60	V	V	V
SXGA	1280 × 800 @ 60	V	V	V
SXGA	1280 × 960 @ 60	V	V	V
SXGA	1280 × 1024 @ 60	V	V	V
SXGA	1280 × 1024 @ 75	V	V	V
WXGA+	1440 × 900 @ 60	V	V	V
WXGA+	1440 × 900 @ 75	V	V	V
WSXGA+	1680 × 1050 @ 60	V	V	V
FHD	1920 × 1080 @ 60	V	V	V
FHD	1920 × 1200 @ 60	V	V	V
FHD	1920 × 1200 @ 75	V	V	V
QHD	2560 x 1440 @ 60	V	V	V
QHD	2560 x 1440 @ 75	V	V	V
QHD	2560 x 1600 @ 60	V	V	V
QHD	2560 x 1600 @ 75	V	V	V
Ultra-Wide QHD	3840 x 1600 @ 60	V	V	V
Ultra-Wide QHD	3840 x 1600 @ 75	V	V	V

Video Timing Resolution

Standard	Resolution (Hz)	TYPE-C	HDMI	DP
480p	640 x 480p @60Hz	V	V	V
480p	720 x 480p @60Hz	V	V	V
576p	720 x 576p @50Hz	V	V	V
720p	1280 x 720p @50Hz	V	V	V
720p	1280 x 720p @60Hz	V	V	V
576p	1440 x 576p @50Hz	V	V	V
1080p	1920 x 1080p @50Hz	V	V	V
1080p	1920 x 1080p @60Hz	V	V	V

Technical Information

LCD Panel	Driving system	TFT Color LCD
	Size	95.25 cm(37.5")
	Pixel pitch	0.22908 (H) x 0.0.22908 (V) mm
	Curvature	2300R
Input	Video	Digital
	H-Frequency	97.4-99.6 kHz
	V-Frequency	59.4-60.6 Hz
Display Colors		1.07 Billion colors
Max. Resolution		3840x1600 @75Hz
Plug & Play		DDC 1/ 2B / CI or VESA DDC2B™
Power Consumption	Power On(typ.)	≤ 38 W
	Power Saving	≤ 0.5 W
	Power Off	≤ 0.3 W
Input Connector		20-pin Displayport 2 x 19-pin HDMI USB Type-C USB Type-B 2 x USB Type A
Input Video Signal		1xDisplayPort 1.2 1xHDMI 2.0 1xUSB type-C
Output Connector		1xHeadphone out
Speaker		2W x 2
USB		USB-C x 1 (Upstream) (5Gbps) USB B 3.2 (Gen 1) x 1 (Upstream (5Gbps) USB A 3.2 Gen 1 x 2 (Downstream)
USB C Power Delivery		USB C (PD96W) (5V/3A, 9V/3A, 12V/3A, 15V/3A, 20V/4.8A)
Power Source		100~240VAC,50/60Hz
Environmental Considerations		Operating Temp: 0°C to 40°C Non-Operating Temp.: -20°C to 60°C Operating Humidity: 10% to 85%
Dimensions (W x H X D)		897.5 mm x506.9 mm x 237.8 mm
Weight (N.W.)		9.4 kg

Wall-mounted installation instructions

When you want to hang the display device on a wall or other bracket. Follow the following steps:

1. Place the display front-facing down on the styrofoam and assemble the wall-mounted adapter
2. Assemble the wall-mounted supports, and then install the wall-mounted screws.

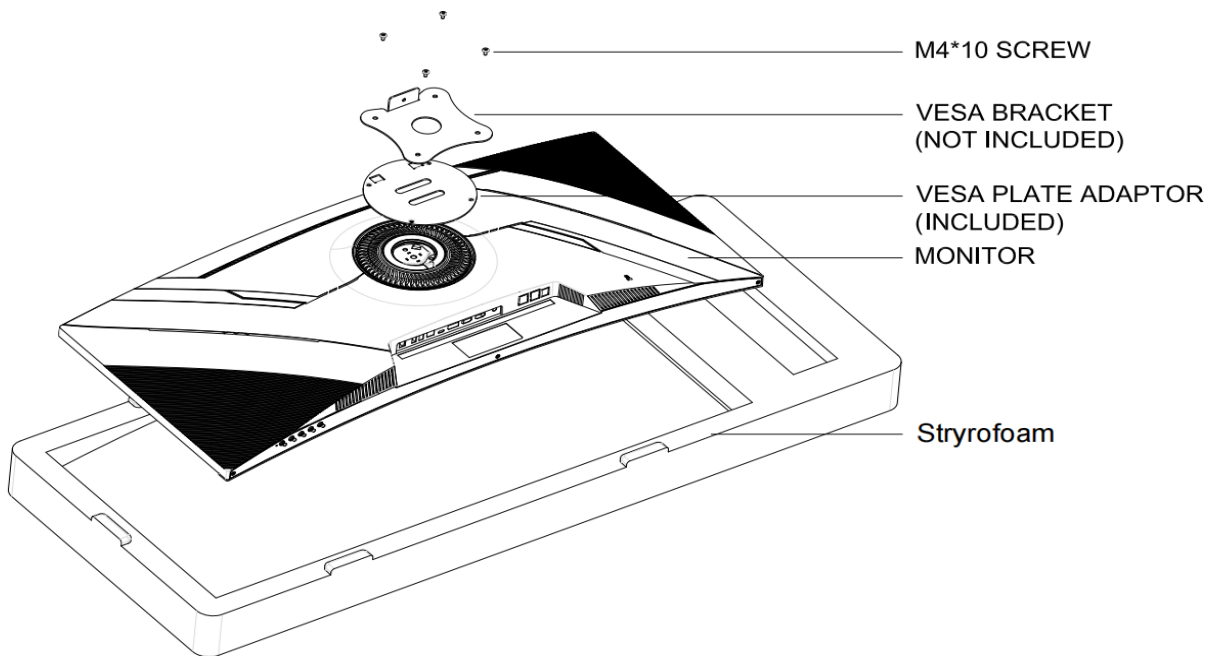

3. Wall-mounted display

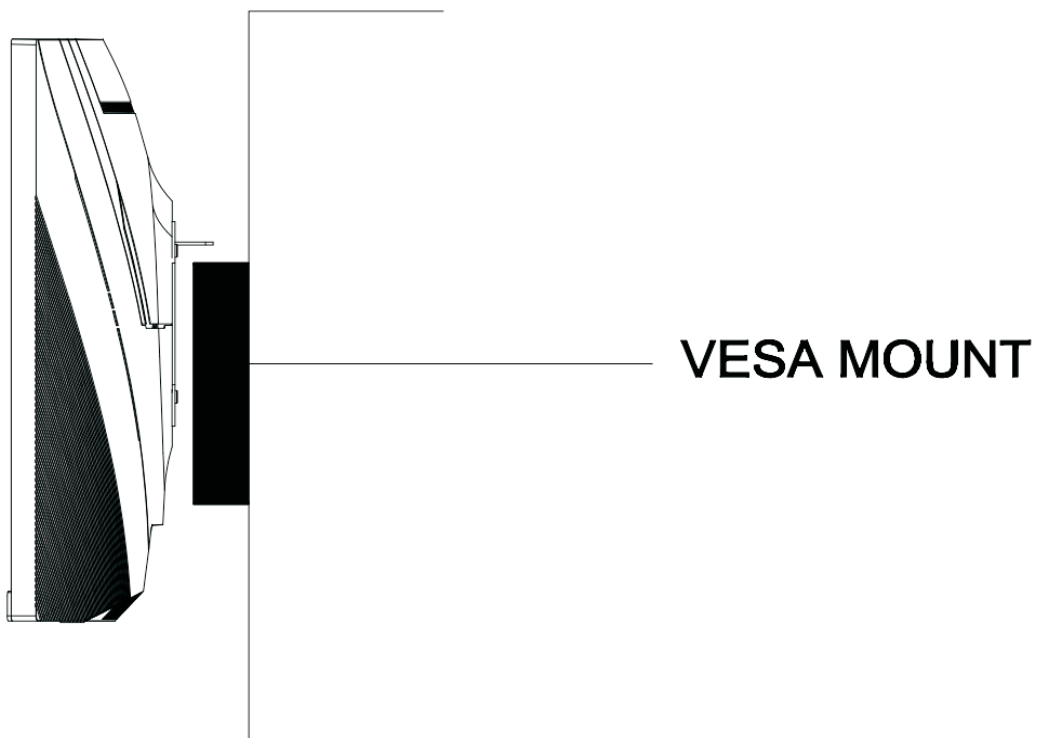

Care and Maintenance

Care

- Avoid exposing your LED LCD monitor directly to sunlight or other heat source. Place your LED LCD monitor away from the sun to reduce glare.
- Put your LED LCD monitor in a well ventilated area.
- Do not place any heavy things on top of your LED LCD monitor.
- Make certain your LED LCD monitor is installed in a clean and moisture-free area.
- Keep your LED LCD monitor away from magnets, motors, transformers, speakers and TV sets.

Note

- Move the LED out of the package and take off the plastic bag and Polystyrene Foam.
- Pull the base from Parallel versus Panel to Vertical.
- Adjust the Panel within -5° leaning forward and 15° leaning backward.

Safety Tips

- If smoke, abnormal noise or odor came out from your LED LCD monitor, caution you should remove the power cord immediately and call your service center.
- Si de fumée, un bruit anormal ou une odeur séchappait de votre moniteur, débranchez immédiatement le cordon d'alimentation et appelez votre centre de service.
- Never remove the rear cover of your LED LCD monitor cabinet. The display unit inside contains high-voltage parts and may cause electric shock to human bodies.
- Never try to repair your LED LCD monitor yourself. Always call your service center or a qualified technician to fix it.

Troubleshooting

No power

- Make sure A/C power cord is securely connected to the power adapter and the power supply if firmly connected to the LED LCD Monitor.
- Plug another electrical device into the power outlet to verify that the outlet is supplying proper voltage.
- Make sure all signal cables are installed.

Power on but no screen image

- Make sure the video cable supplied with the LED LCD Monitor is tightly secured to the video output port on back of the computer. If not, tightly secure it.
- Adjust brightness.

Wrong or abnormal colors

- If any colors (red, green, blue) are missing, check the video cable to make sure it is securely connected. Loose or broken pins in the cable connector could cause an improper connection.
- Connect the LED LCD Monitor to another computer.

Planar Support

Cables and Accessories

To find cables and accessories for your Planar monitor, touch screen or other Planar products visit our online store at www.PlanarOnline.com.

Technical Support

Visit Planar at <http://www.planar.com/support> for operations manuals, touchscreen drivers, warranty information and access to Planar's Technical Library for online trouble shooting. To speak with Planar Customer Support please have your model and serial number available and dial:

Planar Support

Tel: 1-866-PLANAR1 (866-752-6271) or + 1 503-748-5799 outside the US.

Hours: 24 hours a day, 7 days a week.

Toll or long distance charges may apply.

European Product Database for Energy Labelling (EPREL)

PZN3815Q Registration number: 2184260

Planar Systems, Inc.

Customer Service

24x7 Online Technical Support: <http://www.planar.com/support>

6799 NE Bennett Street, Hillsboro OR 97124

Tel: 1-866-PLANAR1 (866-752-6271), or + 1 503-748-5799 outside the United States,

Hours: 24 hours a day, 7 days a week

© 1/2025 Planar Systems, Inc.

Planar is a registered trademark of Planar Systems, Inc. Other brands and names are the property of their respective owners. Technical information in this document is subject to change without notice.