



PXL2780MW LED LCD Monitor

USER'S GUIDE

www.planar.com

Planar utilizes HDMI® standards in this product.

The terms HDMI, HDMI High-Definition Multimedia Interface, HDMI Trade dress and the HDMI Logos are trademarks or registered trademarks of HDMI Licensing Administrator, Inc.

Content

Operation Instructions.....	1
Unpacking Instructions	3
Safety Precautions	3
Package Overview	5
First Setup.....	6
Front View of the Product	7
Rear View of the Product	8
Quick Installation	9
Basic Operation.....	10
Advanced Operation—OSD Menu.....	12
Supporting Timing Modes	17
Technical Information	18
Wall-Mount Installation Instructions	19
Troubleshooting.....	20
Planar Support	21

Operation Instructions

Thank you for purchasing the PXL2780MW LED LCD monitor. Please read this guide thoroughly before installation.

FCC RADIO FREQUENCY INTERFERENCE STATEMENT WARNING: (FOR FCC CERTIFIED MODELS)

This LED LCD Monitor has been tested and found compliant with the limits for a Class B digital device, pursuant to part 15 of the FCC Rules. These limits are designed to provide proper protection against harmful interference to a residential installation. This LED LCD Monitor generates, uses, and can radiate radio frequency energy. Harmful interference to radio communication may be the result if it's not properly installed and used. However, there is no guarantee that interference will not occur in a particular installation. If this LED LCD Monitor does cause serious interference to radio or television reception, resetting may correct it. Moreover, users are encouraged to reduce interference by doing one or more of the following:

- Reorient or relocate the receiving antenna.
- Move the LED LCD Monitor and the receiver further away from each other.
- Connect the LED LCD Monitor into an outlet on a circuit different from that to which the receiver is connected.
- Consult your local dealer or a qualified technician.

FCC Warning:

To assure a continued FCC compliance, a user must use a grounded power supply cord and the provided shielded video interface cable with bonded ferrite cores. Also, any unauthorized changes or modifications to this LED LCD Monitor would void the user's authority to operate this device.

Note: If necessary, shielded interface cables and AC power cord must be used to meet the emission level limits.



Important Waste Disposal Information

Please recycle or dispose of all electronic waste in accordance with local, state, and federal laws. Additional resources can be found online at <http://www.planar.com/about/green/>.

The crossed-out wheeled bin symbol is to notify consumers in areas subject to Waste Electrical and Electronic Equipment (WEEE) Directive 2012/19/EU that the product was placed on the market after August 13, 2005 and must not be disposed of with other waste. Separate collection and recycling of electronic waste at the time of disposal ensures that it is recycled in a manner that minimizes impacts to human health and the environment. For more information about the proper disposal of electronic waste, please contact your local authority, your household waste disposal service, or the seller from whom you purchased the product.

COMMUNIQUE D'AVERTISSEMENT DE LA FCC CONCERNANT LES INTERFERENCE DE FREQUENCE RADIO: (SEULEMENT POUR MODELES CERTIFIE PAR LA FCC)

Ce moniteur a été testé et à été trouvé conforme aux limites pour un appareil numérique de Classe B, suivant la partie 15 des règlements de la FCC. Ces limites ont été développées pour offrir une protection satisfaisante contre les interférences nuisibles dans une installation résidentielle. Ce moniteur génère, utilise et peut radier de l'énergie de fréquence radio. Ceci peut causer des interférences nuisibles à des communication radio si l'appareil n'est pas convenablement installé et utilisé. Il n'y a néanmoins aucune garantie que des interférences n'apparaîtront pas dans une installation particulière. Si ce moniteur cause de sérieuses interférences à la réception de signaux radios ou télévisées, une possibilité est de réinitialiser le moniteur. Les usagers sont aussi encouragés à corriger les interférences en appliquant une ou plusieurs des démarches suivantes:

- Réorientez ou déplacez l'antenne de réception.
- Placez le moniteur et le récepteur plus loin l'un de l'autre.
- Connectez le moniteur à une prise différente de celle à laquelle le récepteur est connecté.
- Consultez votre revendeur local ou un technicien qualifié.

Avertissement de la FCC:

Pour assurez une conformité continue au règlements de la FCC, l'utilisateur doit utiliser un cordon d'alimentation mis à terre et le câble d'interface vidéo protégé avec noyaux en ferrite, fourni avec l'appareil. Chaque modification ou changement non-autorisé appliqué à ce moniteur peut faire perdre à l'utilisateur sont droit d'opération de cet appareil.

Note: Si nécessaire, des câbles d'interface protégés et un cordon d'alimentation alternante doivent être utilisé pour être conforme aux limites d'émission.

Unpacking Instructions

- Remove the LED LCD Monitor out of the package and take off the plastic bag and Polystyrene Foam.
- Remove base from plastic bag and attach to base.
- Adjust the display between -5° and 20°.

Safety Precautions

Follow all warnings, precautions and maintenance as recommended in this user's manual to maximize the life of your unit.

Do:

- Turn off the product before cleaning.
- LED Display screen surface may be cleaned using a soft clean cloth moistened with mild window glass commercial cleaners or 50/50 mixture of water and isopropyl alcohol.
- Use a soft cloth moistened with mild detergent to clean the display housing.
- Disconnect the power plug from AC outlet if the product is not going to be used for an extended period of time.

Don't:

- Do not touch the LED Display screen surface with sharp or hard objects.
- Do not use abrasive cleaners, waxes or solvents for your cleaning.
- Do not operate the product under the following conditions:
 - Over 16 hours per day.
 - Extremely hot, cold or humid environment.
 - Areas susceptible to excessive dust and dirt.
 - Near any appliance generating a strong magnetic field.
 - In direct sunlight.
- If smoke, abnormal noise or odor emits from your LED LCD Monitor, remove the power cord immediately and call your service center.
- Never remove the rear cover of your LED LCD Monitor. The display unit inside contains high-voltage parts and may cause electric shock.
- Never try to repair your LED LCD Monitor yourself. Always call your service center or a qualified technician to fix it.
- Due to safety concerns, if the VESA mounting kit is purchased separately, please make sure the mounting kit is UL-listed, and replaceable only by service personnel.

Consignes de sécurité

Respectez tous les avertissements, les précautions et conseils d'entretien recommandés dans ce manuel de l'utilisateur pour maximiser la durée de vie de votre appareil.

A faire :

- Éteindre le produit avant de le nettoyer.
- La surface de l'écran tactile peut être nettoyée avec un chiffon doux et propre imprégné d'un nettoyant doux du commerce pour vitres ou d'un mélange à 50/50 d'alcool isopropylique et d'eau.
- Utilisez un chiffon doux imprégné d'un détergeant doux pour nettoyer le carter de l'affichage.
- Débranchez la fiche d'alimentation de la prise de courant secteur si le produit ne doit pas être utilisé pendant une période prolongée.

A ne pas faire :

- Ne touchez pas la surface de l'écran LED avec des objets coupants ou durs.
- N'utilisez pas des produits de nettoyage abrasifs, de la cire ou des solvants pour le nettoyage.
- N'utilisez pas le produit dans les conditions suivantes :
 - Plus de 16 heures par jour.
 - Environnement extrêmement chaud, froid ou humide.
 - Endroits poussiéreux ou sales.
 - Près d'appareils générant un fort champ magnétique.
 - Sous la lumière directe du soleil.
- Si de la fumée, un bruit anormal ou une odeur s'échappait de votre moniteur LCD LED, débranchez immédiatement le cordon d'alimentation et appelez votre centre de réparation.
- Ne retirez jamais le couvercle arrière de votre moniteur LCD LED. L'unité d'affichage contient des éléments où circule un voltage élevé et présentant un risque d'électrocution.
- N'essayez jamais de réparer vous-même votre moniteur LCD LED. Faites toujours appel à votre centre de service ou à un technicien qualifié pour toute réparation.
- Pour des raisons de sécurité, si vous achetez séparément le kit de fixation VESA, assurez-vous que celui-ci est certifié UL, et qu'il peut être remplacé uniquement par un technicien qualifié.

Package Overview

Congratulations on your purchase of this high performance LED edge lit, LCD monitor. This LED LCD Monitor comes with the following accessories:

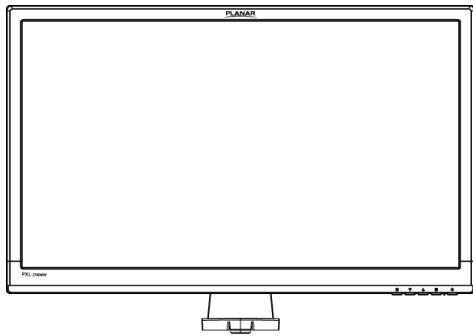

LED LCD Monitor

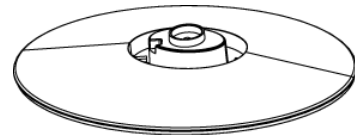

Base



Power Cord

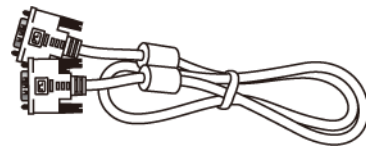

DVI Cable (Dual Link)



Audio-in Cable

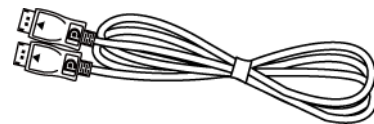

Display Port Cable



User's Guide

First Setup

Install the stand base

1. Lay the LED LCD Monitor flat on a table with the LED screen face down. To prevent the LED LCD Monitor from being scratched, put a piece of soft cloth on the table on which the screen will be set.
2. Align the monitor with the opening in the base.
3. Turn the screw clockwise to attach the base to the monitor.
4. Stand the LED LCD Monitor up.

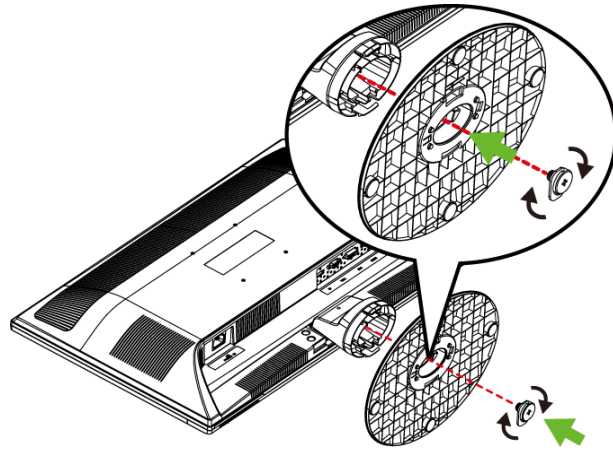

Disconnecting the stand base

1. Lay the LED LCD Monitor flat on a table with the LED screen face down. To prevent the LED LCD Monitor from being scratched, put a piece of soft cloth on the table on which the screen will be set.
2. Turn the screw counterclockwise to remove the screw that holding your monitor to the base.
3. Remove the base from the stand.

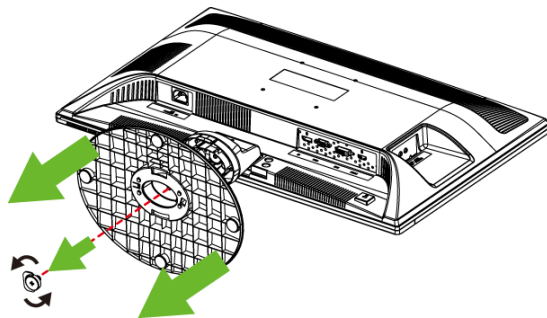

Front View of the Product

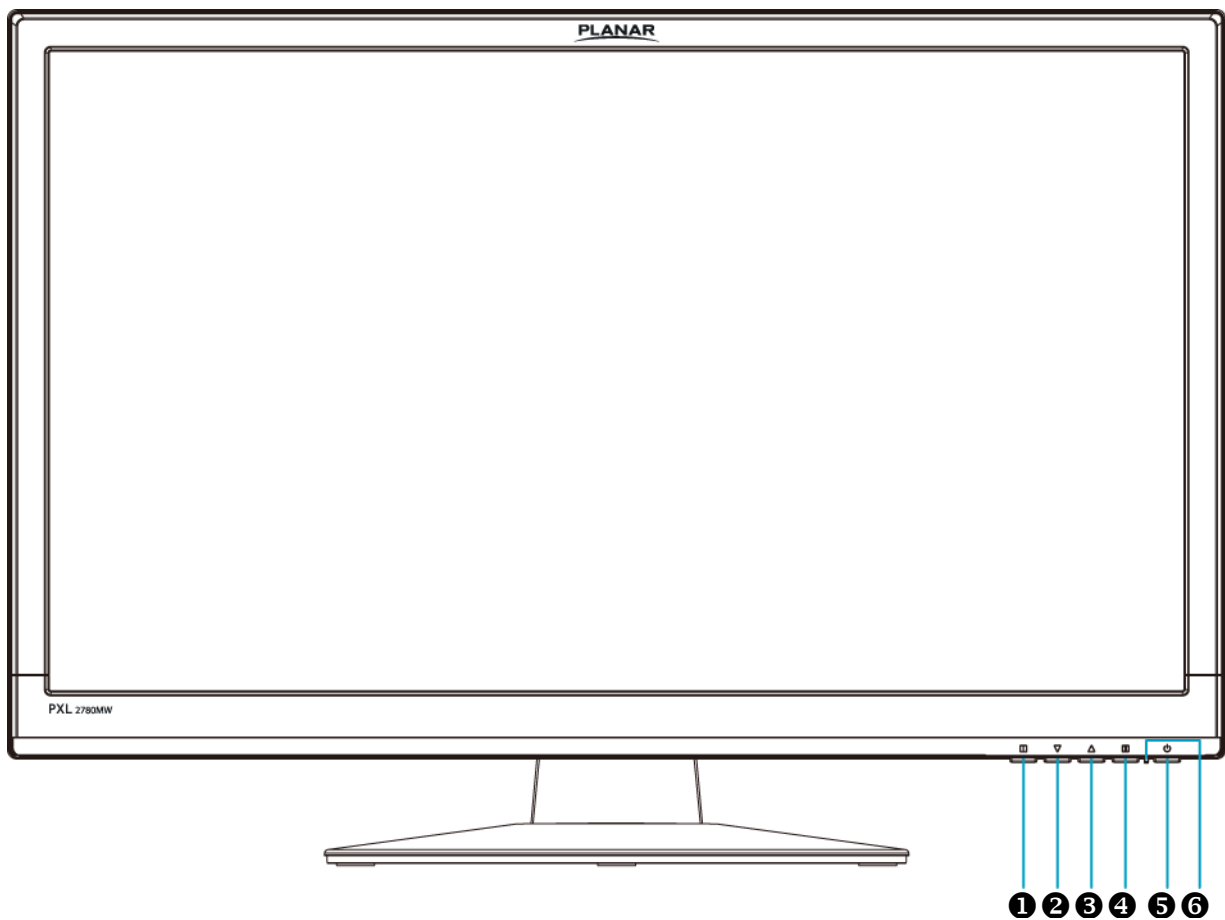

①	OSD Turn On/ Off
②	Scroll Down/ Adjust Decrease/ Blue Light Reducer *
③	Scroll UP/ Adjust Increase/ Brightness
④	Input select/ Confirm Selection/ Auto *
⑤	Power On/Off
⑥	LED Indicator

* Hot keys Instructions please see "Using the OSD Menu" on page 10.

Rear View of the Product

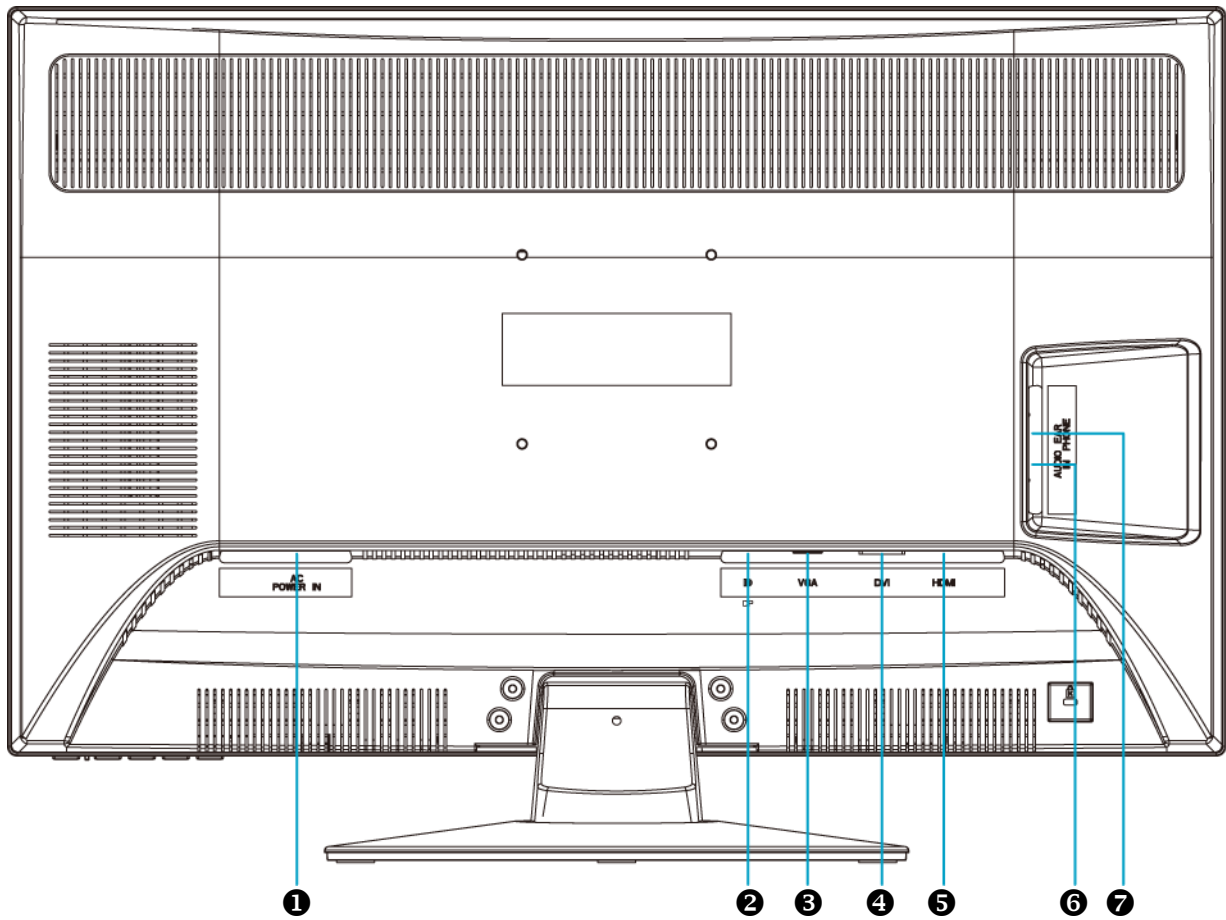

①	Power Input
②	Display Port Input (Display Port 20 pin)
③	VGA Input (D-Sub 15 pin)
④	DVI Input (DVI 24 pin)
⑤	HDMI input (HDMI 19 pin)
⑥	Audio Input
⑦	Headphone Jack

Quick Installation

1. Connect either DVI or Display Port Video source from the monitor to the computer, using the included DVI-dual link or Display Port cable. Make sure both monitor and computer are powered OFF.
Note: VGA and HDMI cables may be sourced separately from a cable supplier.
2. Connect the audio cable from audio output of computer to the audio input of the monitor.
3. Connect the earphone to the earphone output terminal of the monitor. (Earphone sold separately).
4. Connect power cord to a properly grounded AC outlet, and then to the monitor.
5. Power-ON computer and then POWER-ON the monitor.
6. Set the timing mode on your computer. Recommended resolution and refresh rate is 2560 x 1440 @ 60Hz.

Note: VGA and HDMI inputs do not support 2560 x 1440 resolution. It is only supported on DVI input, using a DVI dual link cable, and Display Port input, using Display Port cable.

Figure 1:

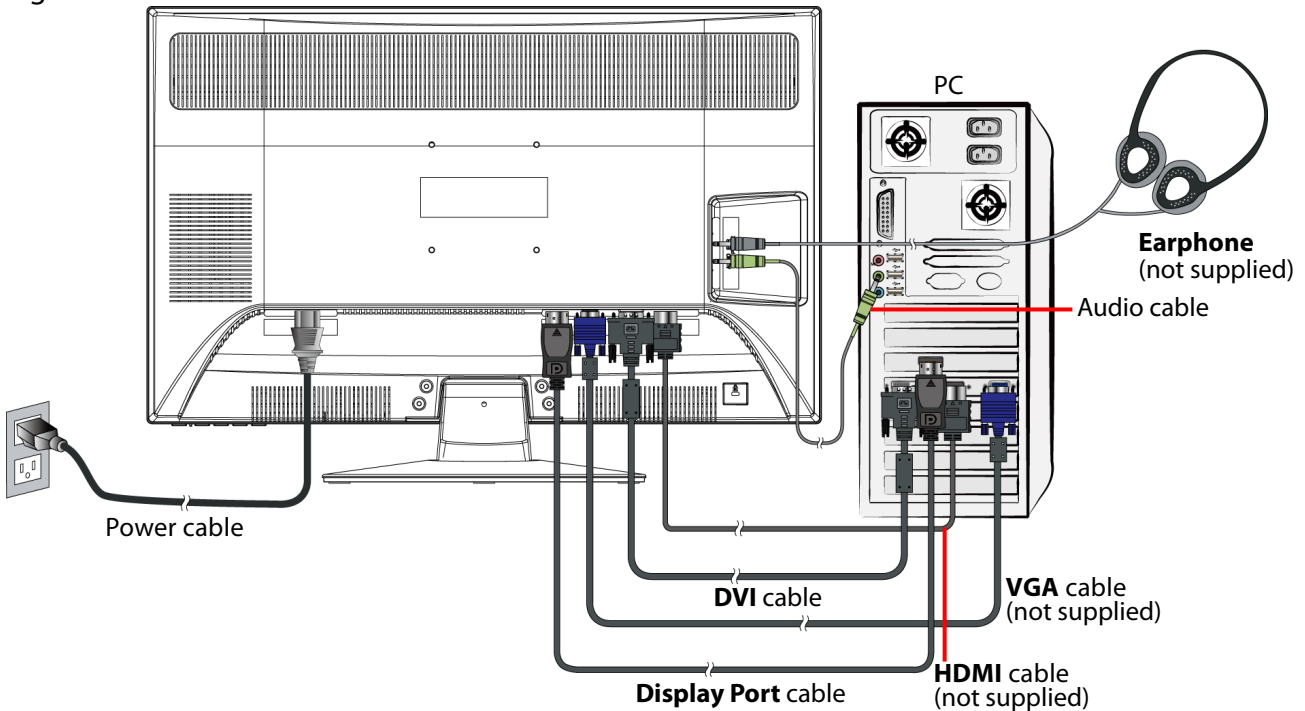

Basic Operation

Before using the LED LCD Monitor:

- Connect external equipment properly.
- Insert the power plug, and the power LED indicator will light orange.

Power On/Off

To turn the LED LCD Monitor on/off:

Press  Power button on the front of LED LCD Monitor. The power LED indicator light will be blue when the LED LCD Monitor is on.

Using the OSD Menu

Use OSD menus to adjust settings by using the menu button on the front of the LED LCD Monitor.

1	Displays main menu
	Exits from OSD menu
2	Selects between VGA, DVI, HDMI, Display Port mode
	When in VGA mode, press 3 seconds activates Auto Image Adjust
▼	Select the desired item when in OSD menu
	When not in OSD menu, directly enters Blue Light Reducer Menu
▲	Select the desired item when in OSD menu
	When not in OSD menu, directly enters Brightness menu

OSD Lock Out Function

When LED LCD Monitor is in normal mode, the “OSD Lock Out” function can be enabled.

Option 1: OSD lock – all 4 buttons are locked except the “POWER” button.

Press and hold the  button and the  button for 3 seconds to lock the OSD buttons.

The LED LCD Monitor will show an “OSD Locked” message for 3 seconds and the message will disappear automatically.

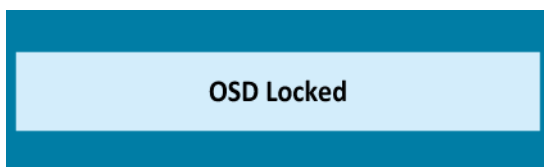

Repeat this step to unlock.

Option 2: OSD & Power button lock – all 5 buttons including the “POWER” button are locked. Press and hold the **1** button and the ▼ button for 3 seconds to lock all 5 buttons.

The LED LCD Monitor will show a “Power Button Locked” message for 3 seconds and the message will disappear automatically.

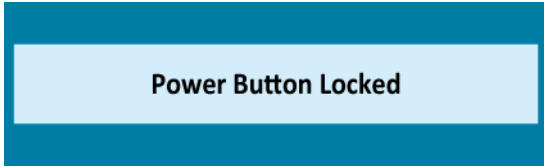

Repeat this step to unlock.

Advanced Operation—OSD Menu

You can use the OSD menu to adjust various settings for your LED LCD Monitor.

Press the **1** button to display the OSD Menu, and use **▼** or **▲** to select the desired OSD menu.

Short Cuts Function from the button(s)

Contrast/Brightness: To manually adjust the Brightness, Contrast, ECO, Over Driver and Gamma of screen image.

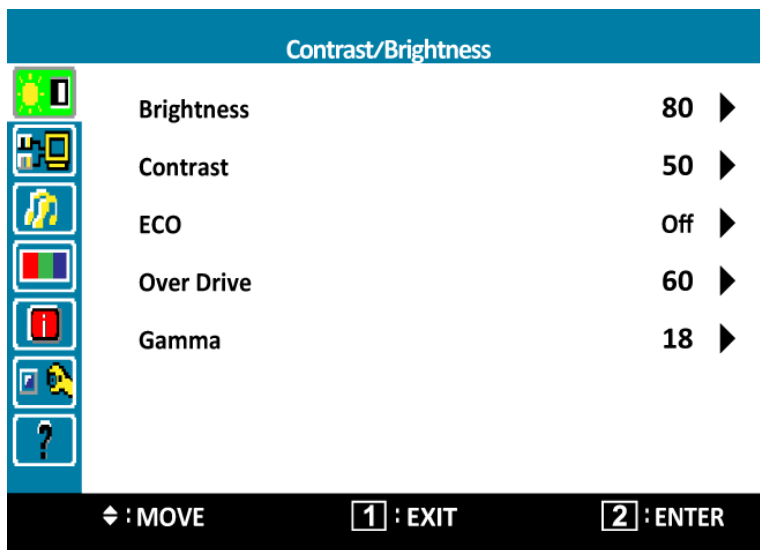

- **Brightness:** To adjust the luminance of the video.
▲ : increase brightness, ▼ : decrease brightness.
- **Contrast:** To adjust the foreground white level of screen image.
▲ : increase contrast, ▼ : decrease contrast.
- **ECO:** Allows the user to turn the ECO On or Off. Contrast and Brightness adjustment disabled when ECO is active.
- **Over Drive:** Allows the user to change the Over Drive strength. Improve the quality of the motion pictures.
Press ▲ or ▼ key to adjust the Over Drive strength in five levels.
- **Gamma:** Allows the user to change the Gamma strength.
Press ▲ or ▼ key to adjust the Gamma strength in four levels.

Input Select: When Input Select is pressed, change Input signal to VGA, DVI, HDMI or Display Port.

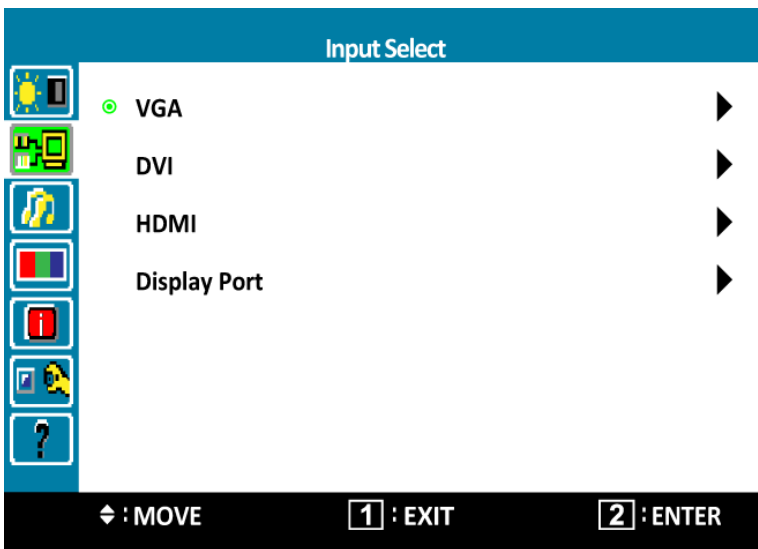

Audio Adjust: To adjust the audio functions.

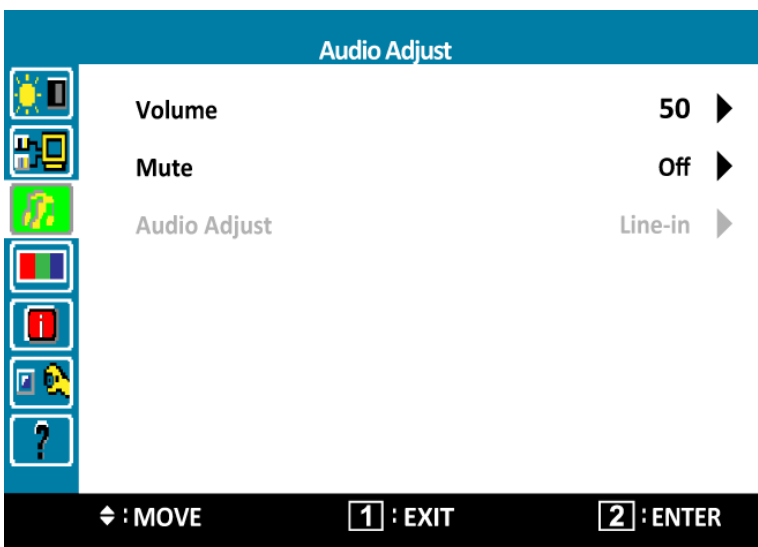

- **Volume:** To adjust the volume of speaker output.
- **Mute:** To turn the Mute ON/OFF.
- **Audio Adjust:** When in HDMI input, select where the audio source comes from Line-in or HDMI. When in Display Port input, select where the audio source comes from Line-in or Display Port.

Color Adjust: To select the color for improving brightness and color saturation between 5000K, 5400K, 6500K, 7500K, 9300K, sRGB, User Color and Blue Light Reducer.

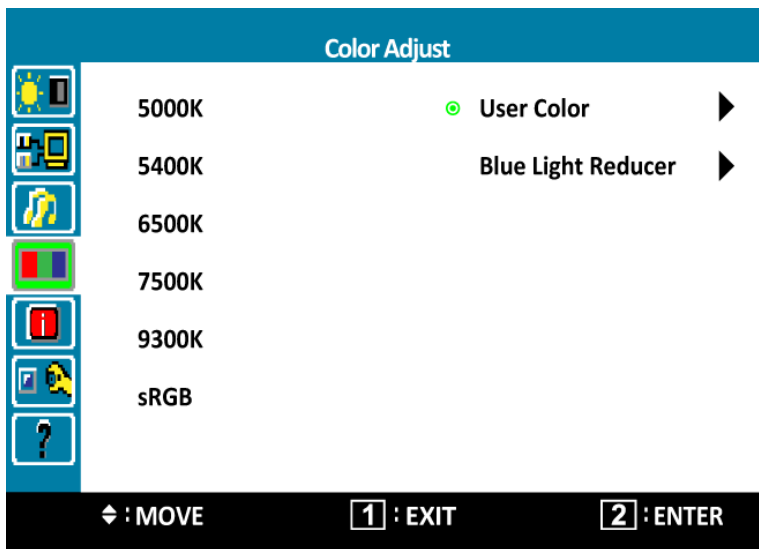

5000K: Most warm color temperature.

5400K: More warm color temperature.

6500K: Normal color temperature.

7500K: More cool color temperature.

9300K: Most cool color temperature.

sRGB: This is quickly becoming the industry standard for color management.

Enabling this setting allows the monitor to more accurately display colors the way they were originally intended. Enabling the sRGB setting will cause the Contrast and Brightness adjustments to be disabled.

User Color: Individual adjustments for red (R), green (G), blue (B).

1. Press button **2** to select the desired color.

2. Press **▲** or **▼** button to adjust selected color.

Blue Light Reducer: To decrease the blue light emitted from the display to reduce the risk of blue light exposure to your eyes. (Contrast and Color Vision Mode adjustment will be disabled when Blue Light Reducer is active.)

Press button **2** to select the Blue Light Reducer.

Press **▲** or **▼** key to adjust the Blue Light Reducer strength.

- Video – Ideal for watching videos (15% reduction)
- Web Browsing – Ideal for web browsing (30% reduction)
- Reading – Ideal for reading (50% reduction)
- Low Light – Ideal for low ambient lighting environments (70% reduction)

Information: To display the information, regarding the current input signal coming from the graphic card in your computer.

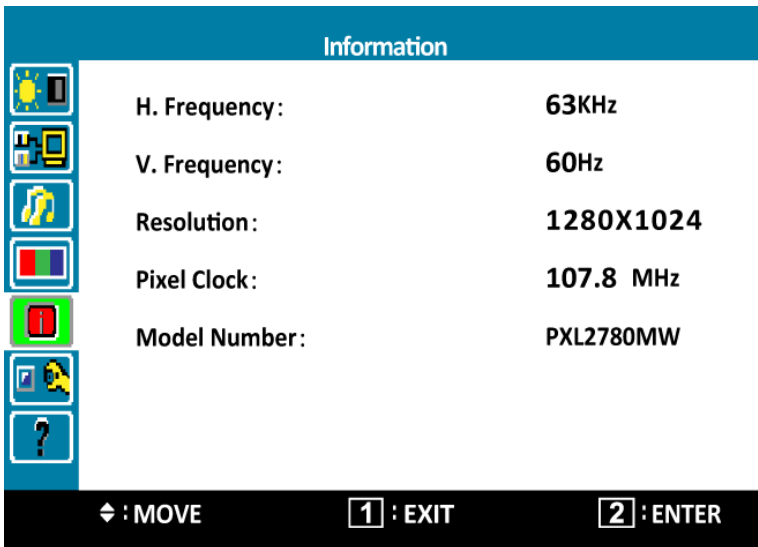

Note: See your graphic card user guide for more information about changing the resolution and refresh rate.

Manual Image Adjust: To manually adjust the H. /V. position, Clock, Phase, Sharpness and Aspect Ratio.

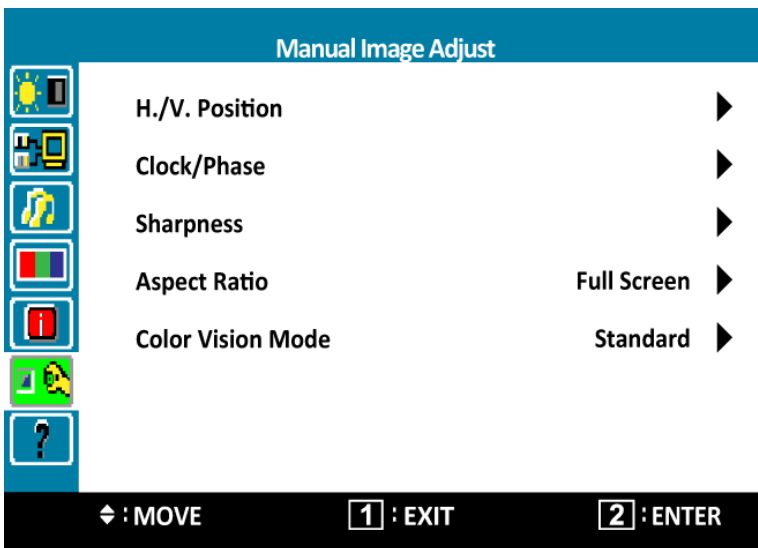

- **H./V. Position:** To adjust the horizontal and vertical position of the video.
 - H. Position:** ▲ : move screen to the right, ▼ : move screen to the left.
 - V. Position:** ▲ : move screen up, ▼ : move screen down.
- **Clock/Phase:** To adjust the delay time of data and clock.
 - Phase:** ▲ : increase phase strength, ▼ : decrease phase strength.
 - Clock:** ▲ : expand the screen size from left to right, ▼ : narrow the screen size from right to left.
- **Sharpness:** To adjust the clarity of a non-QHD Resolution (2560x1440) signal with ▲ or ▼ button.
- **Aspect Ratio:** To select the video mode from Full Screen, 4:3, Overscan or 1:1.

- **Color Vision Mode:** Provides an optimum display environment depending on the contents displayed. It contains 5 user-selectable presets.
Standard is for general windows environment and monitor default setting.
Scenery optimized for displaying outdoor scenery images.
Cinema optimized for movie and video environment.
Game optimized for PC game environment.
Text optimized for text editing and viewing in a word processing environment.

Setup Menu: To set up Language Select, OSD Position, OSD Timeout, OSD Background and LED mode.

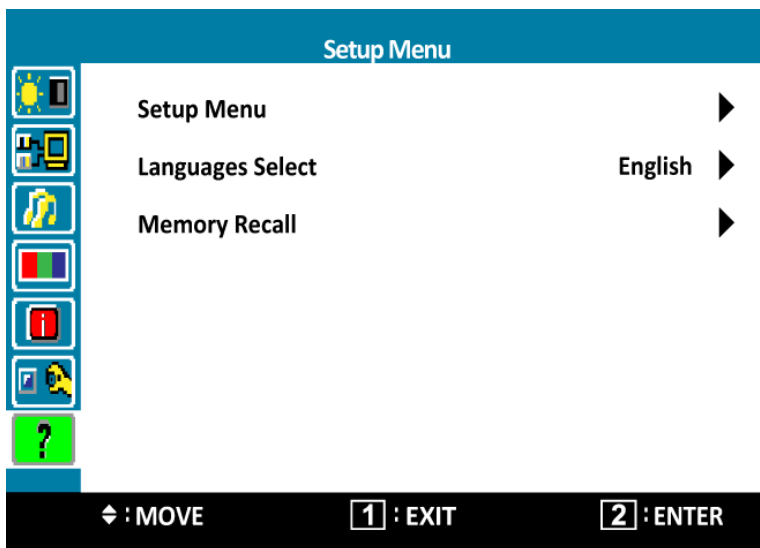

- **Setup Menu:** To set up H. Position, V. Position, OSD Timeout, OSD Background and LED mode.

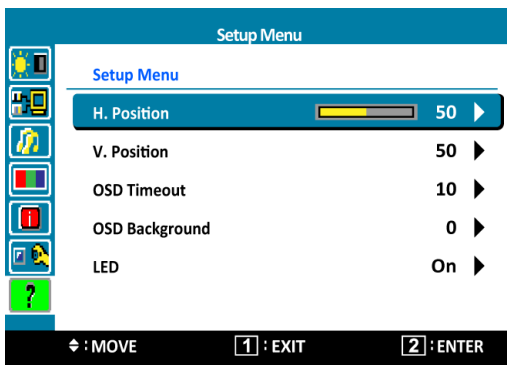

H. Position: To horizontally adjust the OSD position.

▲: move OSD to the right, ▼: move OSD to the left.

V. Position: To vertically adjust the OSD position.

▲: move OSD up, ▼: move OSD down.

OSD Timeout: To automatically turn off On Screen Display (OSD) after a preset period of time.

OSD Background: Allows the user to turn the OSD background On or Off.

LED: Allows the user to turn the LED Indicator On or Off.

- **Language Select:** To allow users to choose from available languages.

- **Memory Recall:** To recall factory settings for Video & Audio controls.

Press button **2** to select the Memory Recall menu option.

Supporting Timing Modes

STANDARD	RESOLUTION
VGA	720 x 400 @ 70Hz
VGA	640 x 480 @ 60Hz
MAC	640 x 480 @ 67Hz
VESA	640 x 480 @ 72Hz
VESA	640 x 480 @ 75Hz
VESA	800 x 600 @ 56Hz
VESA	800 x 600 @ 60Hz
VESA	800 x 600 @ 72Hz
VESA	800 x 600 @ 75Hz
MAC	832 x 624 @ 75Hz
VESA	1024 x 768 @ 60Hz
VESA	1024 x 768 @ 70Hz
VESA	1024 x 768 @ 75Hz
VESA	1280 x 720 @ 60Hz
VESA	1280 x 800 @ 60Hz
VESA	1280 x 1024 @ 60Hz
VESA	1280 x 1024 @ 75Hz
VESA	1440 x 900 @ 60Hz
VESA	1440 x 900 @ 75Hz
VESA	1680 x 1050 @ 60Hz
VESA	1920 x 1080 @ 60Hz
VESA	1920 x 1200 @ 60Hz
VESA	2048 x 1152 @ 60Hz
VESA only DVI (dual link) & DP	1920 x 1440 @ 60Hz
VESA only DVI (dual link) & DP	2560 x 1440 @ 60Hz

Note:

DVI, HDMI and Display Port supports 480i, 480p, 576i, 576p, 720p, 1080i, and 1080p.

Warning: Do not set the graphic card in your computer to exceed these maximum refresh rates. Doing so may result in permanent damage to your LED LCD Monitor.

Avertissement : Ne réglez pas la carte graphique de votre ordinateur en dépassant ces taux de rafraîchissement maximaux. Si vous le faites, cela va irrémédiablement détériorer votre moniteur.

Technical Information

Panel	27" TFT (with LED backlight)	
Power Management	On: 31 Watts (typical), 55 Watts (maximum) Standby Mode: < 0.5 Watt Off: < 0.5 Watt	
Displayable Resolution	QHD 2560 x 1440 max. Vertical Frequency 60Hz max.	
Compatibility	PC	VGA Support up to 2048 x 1152 HDMI Support up to 1920 x 1080 DVI-D/ DP support up to 2560 x 1440 (non-interlaced)
	Mac®	VGA Support up to 2048 x 1152 HDMI Support up to 1920 x 1080 DVI-D/ DP Support up to 2560 x 1440 Note: For Mac® OSX 10.8.3, DVI-D only supports up to 1920 x 1080
Pixel Dimension	0.2331 x 0.2331 mm	
Display Color	16.7M	
Tilt	-5°~20° (±2°)	
Active Display Area	23.49" x 13.22" (596.74 mm x 335.66 mm)	
Temperature	Operating: 0°C ~ +40°C Storage: -20°C ~ + 60°C	
Compliance	FCC-B, CE, UL/cUL	
Power	Input Voltage AC100-240 V	
Audio Output	2W x 2	

Wall-Mount Installation Instructions

Preparing To Install The Optional Wall Mount Arm (not included)

This LED LCD Monitor can be attached to a wall mounting arm you can purchase separately.

Turn the power OFF then disconnect the cables from the LED LCD Monitor before performing the procedure below.

1. Lay the LED LCD Monitor face down on a soft surface.
2. Remove the 4 screws holding the stand to the hinge.
3. Remove the stand.

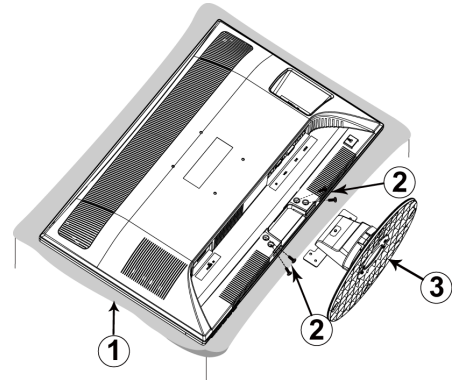

Attaching The Optional Wall Mount Arm (not supplied)

Follow these steps to finish installing the wall mounting arm:

1. Place the wall mounting arm onto the back of the LED LCD Monitor. Line up the holes of the arm with the holes in the back of the monitor.
2. Insert the 4 screws into the holes and tighten.
3. Reconnect the cables. Refer to the User's Guide that came with the optional wall mounting arm for instructions on attaching it to the wall.

100mm x 100mm Screw
Mounting Options

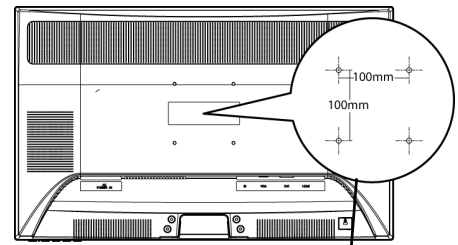

4mm, 0.7 pitch
threaded holes x 4

NOTE

- 100mmx100mm VESA high hole (n=4), M4, pitch =0.7 mm screw mounting kit not included.

Troubleshooting

No power

- Make sure A/C power cord is securely connected to the power supply is firmly connected to the LED LCD Monitor.
- Plug another electrical device into the power outlet to verify that the outlet is supplying proper voltage.
- Make sure all signal cables are installed.

Power on but no screen image

- Make sure the video cable supplied with the LED LCD Monitor is tightly secured to the video output port on back of the computer. If not, tightly secure it.
- Adjust brightness.

Wrong or abnormal colors

- If any colors (red, green, blue) are missing, check the video cable to make sure it is securely connected. Loose or broken pins in the cable connector could cause an improper connection.
- Connect the LED LCD Monitor to another computer.

WQHD resolution not supported

- Make sure your hardware, operating system, content, and graphics card supports up to 2560 x 1440 resolution.
- Only use DVI-dual link and Display Port inputs and cables. VGA and HDMI inputs and cables are not supported.

Planar Support

Cables and Accessories

To find cables and accessories for your Planar monitor, touch screen or other Planar products visit our online store at www.PlanarOnline.com.

Technical Support

Visit Planar at <http://www.planar.com/support> for operations manuals, touchscreen drivers, warranty information and access to Planar's Technical Library for online trouble shooting. To speak with Planar Customer Support please have your model and serial number available and dial:

Planar Support

Tel: 1-866-PLANAR1 (866-752-6271) or +1 503-748-5799 outside the US.

Hours: 24 hours a day, 7 days a week.

Toll or long distance charges may apply.

Planar Systems, Inc.

Customer Service

24x7 Online Technical Support: <http://www.planar.com/support>

1195 NE Compton Drive

Hillsboro, OR 97006

Tel: 1-866-PLANAR1(866-752-6271), or+1 503-748-5799 outside the United States,

Hours: 24 hours a day, 7 days a week

© 04/2020 Planar, Systems, Inc.

Planar is a registered trademark of Planar Systems, Inc. Other brands and names are the property of their respective owners. Technical information in this document is subject to change without notice.

300110000901000

